

HotWire Management Communications Controller (MCC) Card Installation Instructions

Document Number 8000-A2-GN11-00

May 1997

What is an MCC Card?

A Management Communications Controller (MCC) card is a processor circuit card assembly (CCA) that administers and provides diagnostic connectivity to all of the Digital Subscriber Line (DSL) cards in a HotWire 8600 or 8800 DSL Access Multiplexer (DSLAM) chassis. It acts as a mid-level manager and works in conjunction with a Simple Network Management Protocol (SNMP) network management system, such as Paradyne's DCE Manager for HP OpenView, via its Local Area Network (LAN) port. It gathers operational status for each of the DSL cards and HotWire Remote Termination Units (RTUs) and responds to the SNMP requests (via PROXY ARP). It also supports a serial port for local or remote terminal access.

⚠ HANDLING PRECAUTIONS FOR STATIC-SENSITIVE DEVICES



This product is designed to protect sensitive components from damage due to electrostatic discharge (ESD) during normal operation. When performing installation procedures, however, take proper static control precautions to prevent damage to equipment. If you are not sure of the proper static control precautions, contact your nearest sales or service representative.

Package Checklist

Verify that your package contains the following:

- MCC CCA
- DB25 adapter and cable (10 feet in length)
- Warranty card

Tools Required

- Small- to medium-size flat-blade screwdriver to install the MCC card.

Technical Specifications

Specifications	Criteria*
Size	9.15 inches x 11.15 inches x .8 inches
Weight	approx. 1 lb
Approvals Safety Certifications	Refer to the equipment's label for approvals on product.
Power	The MCC card contains a DC-to-DC converter that requires –48V power supply. The –48V power is distributed through the HotWire DSLAM backplane. Maximum Power Dissipation = approx. 8 watts
Physical Environment Operating temperature Storage temperature Relative humidity Shock and vibration	32° to 122° F (0° to 50° C) –4° F (–20° C) to 158° F (70° C) 5% to 85% (noncondensing) Withstands normal shipping and handling.
* Criteria of technical specifications are subject to change without notice.	

Planning the MCC Card Installation

Review the following list to help plan for the installation.

- Obtain the applicable cables; refer to the next section, *Cables You Need*.
- Make sure the HotWire DSLAM chassis is installed and power is supplied to the chassis.
- Determine the type of network management you will be using to monitor and maintain the DSL cards.
 - Management via an SNMP network management system or to a remotely-connected asynchronous terminal via a telnet session over the LAN-connected diagnostic network
 - Local Network Management via a directly-connected terminal console or computer
 - Remote Network Management with a remotely-connected asynchronous terminal or a remotely-connected SNMP manager via a dial-up modem

- After the MCC card is installed, there are configuration instructions that must be performed before you can begin to use the MCC card for network management. Refer to the *HotWire Digital Subscriber Line Access Multiplexer (DSLAM) User's Guide*, Document No. 8000-A2-GB20, for more information.

Cables You Need

The following cables and connectors are used with this product:

- An 8-pin modular cable for connection from the HotWire DSLAM Management MCC port to a 10BaseT hub connector (connected to an SNMP management system network).
- A serial cable for connection from the HotWire DSLAM SERIAL port to a terminal, computer, or modem. In addition, you will also need a:
 - NULL modem adapter (customer provided) and a DB25 cable adapter (provided with this product) when connecting to a modem, or
 - DB25 cable adapter (provided with this product) when connecting to a terminal or computer for local network management.

NOTE:

The 8-pin modular cable must be a Cat5 (grade UTP5) unshielded twisted-pair cable.

If you are connecting to . . .	Use an 8-pin modular . . .
Local terminal console	DB25 adapter cable.
SNMP network management system via a 10BaseT hub connector	Straight-through cable.
Modem for remote management	DB25 adapter cable and NULL MODEM adapter.

Refer to *Pin Assignments* for pinouts.

Installing the MCC Card

When using a . . .	Install the MCC card into . . .
HotWire 8600 DSLAM chassis	Slot 1 of the base chassis (i.e., the chassis set at Stack Position #1).
HotWire 8800 DSLAM chassis	Slot 19.

NOTE:

You will need to remove the filler plate before proceeding to install the MCC card.

Do not discard filler plates. Each slot in the chassis must contain a circuit card or a filler plate to maintain the required EMI shielding and to prevent air leakage from the forced air cooling. Air leakage could result in overheating which may cause the power to the circuit cards to be shut off. Store all unused filler plates in a safe place. You may need to use the filler plates to cover open slots in the chassis at a later time.

► Procedure

To install the MCC card:

1. Remove the filler plate from the appropriate slot.
2. Insert the MCC card into the appropriate slot:
 - **On a HotWire 8600 DSLAM base chassis**, hold the MCC card horizontally with component side facing up and insert it into the left and right card guides of Slot 1. Set the Stack Position Switch to position #1.

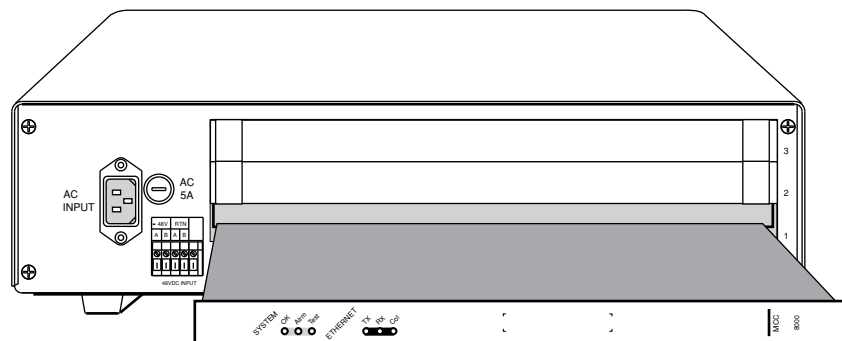

97-15373

- On a HotWire 8800 DSLAM chassis, hold the MCC card vertically with the component side facing right and insert it into the top and bottom card guides of Slot 19.

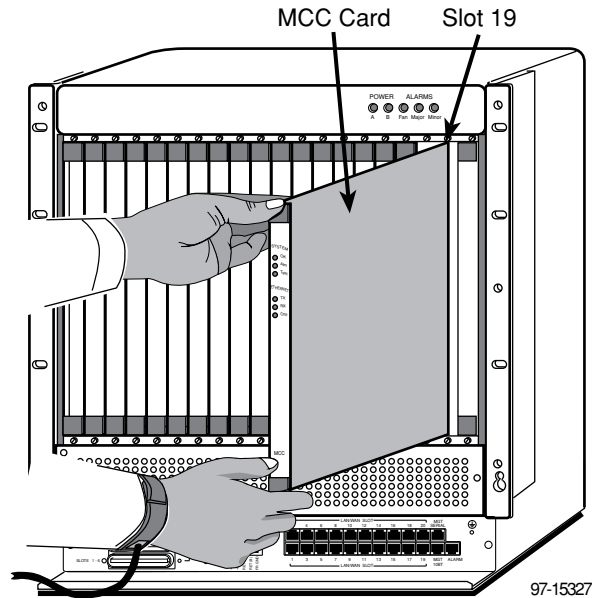

3. Slide the MCC card into the slot. Gently, but firmly, push the card until it properly seats in its mating connectors on the backplane.

CAUTION:

Do not force the MCC card into the slot. If it does not seat properly, remove the card and reinstall it. If it still does not seat properly, call for service.

The MCC card performs a power-up self-test. All of the LEDs turn ON and OFF briefly. When the self-test is completed successfully, the SYSTEM OK LED indicator is ON (winking green).

4. Make sure the SYSTEM OK LED indicator on the MCC faceplate is ON (green). If the LED is not ON, refer to the *Troubleshooting* chapter of the appropriate HotWire DSLAM Installation Guide.
5. Secure the MCC card by fastening the screws on both ends of the faceplate.

NOTE:

The MCC card may be replaced without disruption to user data (i.e., you can remove and re-install the MCC card without powering down the chassis and disrupting service to the other cards). To remove the MCC card from the chassis, unfasten the screws on both ends of the faceplate. Then, simply push the ejector handles outward and slide the card out.

When swapping the old MCC card with a new MCC card, it is important to note that the HotWire DSLAM retains the Media Access Control (MAC) address, also referred to as the physical address. This means that the new MCC card will have the same MAC address as the old one.

Connecting to an SNMP Management System or to a Remote Terminal via a Telnet Session

► Procedure

To connect the HotWire DSLAM chassis that contains the MCC card to an SNMP management system or to a remote terminal via a telnet session over the LAN-connected diagnostic network:

1. Plug the end of an 8-pin modular cable into the MANAGEMENT MCC port of the HotWire DSLAM chassis.
2. Plug the other end of the cable into the 10BaseT hub connector to the SNMP management system network or LAN-connected diagnostic network.

Connecting to a Terminal or Computer for Local Network Management

► Procedure

To connect the HotWire DSLAM chassis that contains the MCC card to a terminal or computer:

1. Plug the 8-pin modular end of the DB25 adapter cable (provided with this product) into the MANAGEMENT SERIAL port of the HotWire DSLAM chassis.
2. Plug the other end of the cable (the DB25 interface side) into your terminal's (or computer's) serial port.
3. Configure your terminal or terminal emulator with the following settings:
 - Baud Rate = 9600
 - Data Bits = 8
 - Parity = No Parity
 - Stop Bits = 1
 - Flow Control = XON/XOFF
 - Terminal Type = vt100

Connecting to a Dial-Up Modem for Remote Network Management

Before connecting the HotWire DSLAM chassis to a standard AT dial-up modem, configure the modem with the following settings:

- Set the modem for auto answer. For example, **ATS0=1**.
- Turn off character echo. For example, **ATE0**.
- Set the modem to ignore Data Terminal Ready (DTR). For example, **AT&D0**.

► Procedure

To connect the HotWire DSLAM chassis that contains the MCC card to a remotely-connected asynchronous terminal or a remotely-connected SNMP manager via a dial-up modem:

1. Plug the 8-pin modular end of the DB25 adapter cable (provided with this product) into the MGT SERIAL port of the HotWire DSLAM chassis.
2. Plug the other end of the cable into your modem's serial port using a DB25 (RS-232 male) adapter and a NULL MODEM adapter.
3. Plug the other end of the cable (the DB25 interface side) into your modem's serial port using a NULL MODEM adapter.

The following illustration shows the cable connection from the HotWire 8800 DSLAM to a dial-up modem:

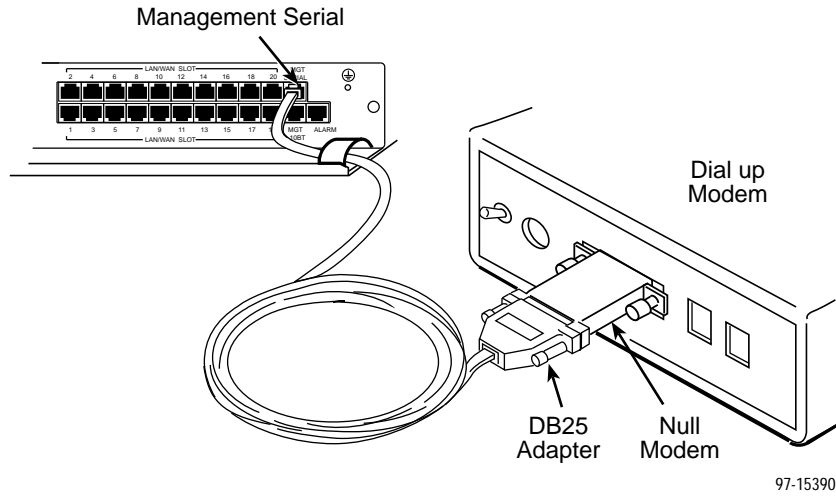

Pin Assignments

8-Pin Modular Connector for MCC Management 10BaseT Connection

On a **HotWire 8600 DSLAM** or **HotWire 8800 DSLAM** – the 8-pin modular connector for the MCC Management 10BaseT Ethernet connection has the following pin assignments:

Pin Number	Use
1	TX Data +
2	TX Data –
3	RX Data +
4	Reserved
5	Reserved
6	RX Data –
7	Reserved
8	Reserved

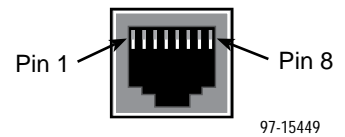

8-pin Modular Management Serial Connector for Asynchronous Terminal Interface

On a **HotWire 8600 DSLAM** – the serial connector for an asynchronous terminal interface (DCE type) has the following pin assignments:

NOTE:

The serial port is active only on the base 8600 chassis.

Pin Number	Function
1	Reserved
2	Reserved
3	Reserved
4	Signal Ground
5	Receive Data
6	Transmit Data
7	Reserved
8	Reserved

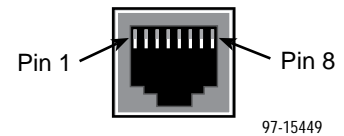

On a **HotWire 8800 DSLAM** – the serial connector for an asynchronous terminal interface (DCE type) has the following pin assignments:

Pin Number	Function
1	Reserved
2	Reserved
3	Reserved
4	Signal Ground
5	Receive Data
6	Transmit Data
7	Reserved
8	Reserved

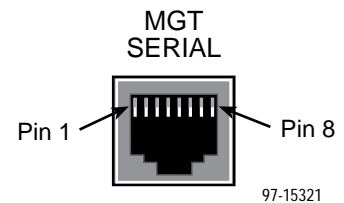

DB25 Adapter Pinouts

The DB25 (RS232 male) cable adapter is used to convert the 8-pin modular serial interface to a standard RS-232 DB25 interface, which can then be connected to a terminal, computer, or modem. The following lists the pin assignments:

8-Pin Modular Serial Interface Pin Number	Use	DB25 Interface Pin Number
1	Unused	–
2	Unused	–
3	Unused	–
4	Signal Ground	7
5	Receive Data	3
6	Transmit Data	2
7	unused	–
8	unused	–

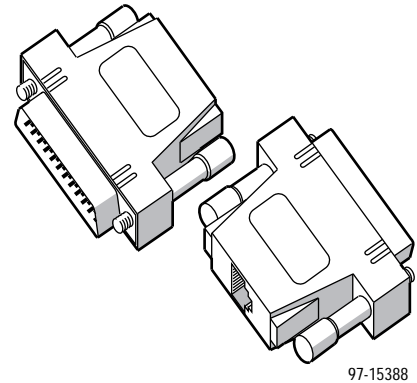

97-15388

MCC Card LEDs

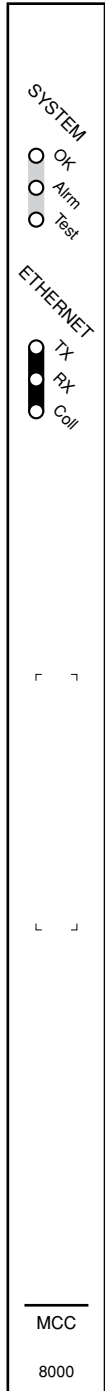

The following table describes the meaning and states of the LEDs on the MCC card faceplate.

Type	LED	LED is . . .	Indicating . . .
SYSTEM	OK	Green, Winking*	Normal operation; card functioning normally.
		Off	No power to card or card failure.
	Alrm	Yellow Off	Alarm present on MCC. Normal operation; no alarms.
ETHERNET	TX	Yellow	Test in progress.
		Off	Normal operation; no tests.
	RX	Green Off Blinking	Link up. Link down. A packet is being sent.
ETHERNET	RX	Green Off Blinking	Link up. Link down. A packet is being received.
		Coll	Off Blinking

* Winking describes a recurring pulse when the LED is ON longer than OFF.