



**HOTWIRE™ 8784
M/HDSL TERMINATION UNIT
WITH DSX-1 INTERFACE
USER'S GUIDE**

Document No. 8784-A2-GB20-00

December 1998

Copyright © 1998 Paradyne Corporation.
All rights reserved.
Printed in U.S.A.

Notice

This publication is protected by federal copyright law. No part of this publication may be copied or distributed, transmitted, transcribed, stored in a retrieval system, or translated into any human or computer language in any form or by any means, electronic, mechanical, magnetic, manual or otherwise, or disclosed to third parties without the express written permission of Paradyne Corporation, 8545 126th Ave. N., Largo, FL 33773.

Paradyne Corporation makes no representation or warranties with respect to the contents hereof and specifically disclaims any implied warranties of merchantability or fitness for a particular purpose. Further, Paradyne Corporation reserves the right to revise this publication and to make changes from time to time in the contents hereof without obligation of Paradyne Corporation to notify any person of such revision or changes.

Changes and enhancements to the product and to the information herein will be documented and issued as a new release to this manual.

Warranty, Sales, and Service Information

Contact your local sales representative, service representative, or distributor directly for any help needed. For additional information concerning warranty, sales, service, repair, installation, documentation, training, distributor locations, or Paradyne worldwide office locations, use one of the following methods:

- **Via the Internet:** Visit the Paradyne World Wide Web site at <http://www.paradyne.com>
- **Via Telephone:** Call our automated call system to receive current information via fax or to speak with a company representative.
 - Within the U.S.A., call 1-800-870-2221
 - Outside the U.S.A., call 1-727-530-2340

Trademarks

All products and services mentioned herein are the trademarks, service marks, registered trademarks or registered service marks of their respective owners.

Document Feedback

We welcome your comments and suggestions about this document. Please mail them to Technical Publications, Paradyne Corporation, 8545 126th Ave. N., Largo, FL 33773, or send e-mail to userdoc@eng.paradyne.com. Include the number and title of this document in your correspondence. Please include your name and phone number if you are willing to provide additional clarification.



Printed on recycled paper

Important Safety Instructions

1. Read and follow all warning notices and instructions marked on the product or included in the manual.
2. Slots and openings in the cabinet are provided for ventilation. To ensure reliable operation of the product and to protect it from overheating, these slots and openings must not be blocked or covered.
3. Do not allow anything to rest on the power cord and do not locate the product where persons will walk on the power cord.
4. Do not attempt to install or service this product yourself, as opening or removing covers may expose you to dangerous high voltage points or other risks. Refer all installation and servicing to qualified service personnel.
5. General purpose cables are provided with this product. Special cables, which may be required by the regulatory inspection authority for the installation site, are the responsibility of the customer.
6. When installed in the final configuration, the product must comply with the applicable Safety Standards and regulatory requirements of the country in which it is installed. If necessary, consult with the appropriate regulatory agencies and inspection authorities to ensure compliance.
7. A rare phenomenon can create a voltage potential between the earth grounds of two or more buildings. If products installed in separate buildings are **interconnected**, the voltage potential may cause a hazardous condition. Consult a qualified electrical consultant to determine whether or not this phenomenon exists and, if necessary, implement corrective action prior to interconnecting the products.
8. In addition, if the equipment is to be used with telecommunications circuits, take the following precautions:
 - Never install telephone wiring during a lightning storm.
 - Never install telephone jacks in wet locations unless the jack is specifically designed for wet locations.
 - Never touch uninsulated telephone wires or terminals unless the telephone line has been disconnected at the network interface.
 - Use caution when installing or modifying telephone lines.
 - Avoid using a telephone (other than a cordless type) during an electrical storm. There may be a remote risk of electric shock from lightning.
 - Do not use the telephone to report a gas leak in the vicinity of the leak.

EMI Warnings

WARNING:

This equipment has been tested and found to comply with the limits for a Class A digital device, pursuant to Part 15 of the FCC rules. These limits are designed to provide reasonable protection against harmful interference when the equipment is operated in a commercial environment. This equipment generates, uses, and can radiate radio frequency energy and, if not installed and used in accordance with the instruction manual, may cause harmful interference to radio communications. Operation of this equipment in a residential area is likely to cause harmful interference in which case the user will be required to correct the interference at his own expense.

The authority to operate this equipment is conditioned by the requirements that no modifications will be made to the equipment unless the changes or modifications are expressly approved by Paradyne Corporation.

WARNING:

To Users of Digital Apparatus in Canada:

This Class A digital apparatus meets all requirements of the Canadian interference-causing equipment regulations.

Cet appareil numérique de la classe A respecte toutes les exigences du règlement sur le matériel brouilleur du Canada.

Contents

About This Guide

- Document Purpose and Intended Audience v
- Document Summary v
- Product-Related Documents vi

1 About the Hotwire 8784 Termination Unit

- M/HDSL Overview 1-1
- Hotwire 8784 Termination Unit Features 1-1
- Network Configuration 1-3
- User Interface Types 1-4
- SNMP Management Capabilities 1-4
 - Management Information Base (MIB) Support 1-4
 - SNMP Trap Support 1-5

2 Using the Asynchronous Terminal Interface

- User Interface Access 2-1
- Management Serial Port Settings 2-1
- Logging In to the Hotwire DSLAM 2-2
- Selecting the 8784 Card from the DSLAM 2-3
- Initiating an ATI Session 2-4
- Screen Work Areas 2-7
- Navigating the Screens 2-8
 - Keyboard Keys 2-8
 - Screen Function Keys 2-9
 - Switching Between Screen Work Areas 2-10
- Ending an ATI Session 2-11
- Exiting From the DSLAM Session 2-11

3 Initial Startup and Configuration

- Overview 3-1
- Entering Identity Information 3-2
- Configuring the 8784 Termination Unit 3-3
 - Configuration Options 3-3
- Accessing and Displaying Configuration Options 3-4
- Configuration Edit/Display 3-5
- Configuration Loader 3-6
- Saving Configuration Options 3-8
- Restoring Access to the User Interface 3-9
- Download Code 3-9

4 Monitoring the 8784 Termination Unit

- What to Monitor 4-1
- Viewing System and Test Status 4-2
 - Health and Status 4-3
 - Self-Test Results 4-5
 - Test Status 4-6
- Viewing Network Error Statistics 4-7
- Viewing Network Performance Statistics 4-8
- Viewing DSX-1 Performance Statistics 4-10
- Viewing 8784 Termination Unit LEDs 4-12
- 8784 Termination Unit LEDs 4-13

5 Testing

- Accessing the Test Menu 5-1
- Running Network Tests 5-2
 - Line Loopback 5-3
 - Repeater Loopback 5-4
 - DTE Loopback 5-5
 - Send Remote Line Loopback 5-6
 - Send and Monitor 511 5-7
- Device Tests 5-8
 - Lamp Test 5-8
- Ending an Active Test 5-9

6 Messages and Troubleshooting

- Overview 6-1
- Configuring SNMP Traps 6-2
- Device Messages 6-3
- Troubleshooting 6-5

7 Security

- Overview 7-1
- ATI Access Levels 7-1
- Creating a Login 7-2
- Deleting a Login 7-4
- Controlling SNMP Access 7-4
 - Assigning SNMP Community Names and Access Types 7-4
 - Limiting SNMP Access through the IP Addresses of the Managers . 7-5

8 IP Addressing

- Selecting an IP Addressing Scheme 8-1
- IP Addressing Example 8-2

A Configuration Option Tables

- Overview A-1
- Network Interface Options Menu A-2
- DSX-1 Interface Options A-4
- Copy Ports Options A-6
- System Options A-7
- Management and Communication Options Menu A-9
 - Telnet Session Options A-9
 - SNMP Traps Options A-11
 - General SNMP Management Options A-14
 - SNMP NMS Security Options A-16

B Standards Compliance for SNMP Traps

- SNMP Traps B-1
 - warmStart B-1
 - authenticationFailure B-1
 - linkUp and linkDown B-2
- Enterprise-Specific Traps B-3

C Cables and Pin Assignments

- Overview C-1
- Hotwire 8600 DSLAM Telco 50-pin Connector Pinouts for DSL Loops .. C-2
- Hotwire 8800 DSLAM Telco 50-pin Connector Pinouts for DSL Loops .. C-3
- Hotwire 8784 Front Panel 50-pin DTE Connector Pinouts C-4

D Technical Specifications

Glossary

Index

About This Guide

Document Purpose and Intended Audience

This guide contains information needed to set up, configure, and operate the 2-port Hotwire 8784 Multirate/Symmetric Digital Subscriber Line (M/HDSL) Termination Unit and is intended for installers and operators.

Document Summary

Section	Description
Chapter 1	<i>About the Hotwire 8784 Termination Unit.</i> Describes the Model 8784 Termination Unit's features and capabilities.
Chapter 2	<i>Using the Asynchronous Terminal Interface.</i> Provides instructions for accessing the user interface and navigating through the screens.
Chapter 3	<i>Customizing the 8784 Termination Unit.</i> Provides procedures for setting up the user interface, configuration steps, and call setup.
Chapter 4	<i>Monitoring the 8784 Termination Unit.</i> Describes using the LEDs, status, and network statistics to monitor the unit.
Chapter 5	<i>Testing.</i> Provides information about available tests and test setup.
Chapter 6	<i>Messages and Troubleshooting.</i> Provides information on SNMP traps, device messages, and troubleshooting.
Chapter 7	<i>Security.</i> Presents procedures for creating a login, setting the effective access levels, and controlling SNMP access.
Chapter 8	<i>IP Addressing.</i> Provides information and examples regarding IP addresses.

Section	Description
Appendix A	<i>Configuration Option Tables.</i> Contains all configuration options, default settings, and possible settings.
Appendix B	<i>Standards Compliance for SNMP Traps.</i> Contains SNMP trap compliance information.
Appendix C	<i>Cables and Pin Assignments.</i> Contains connector and interface information.
Appendix D	<i>Technical Specifications.</i> Contains physical and regulatory specifications, network and port interfaces, power consumption values, and accessory part numbers.
Glossary	Defines acronyms and terms used in this document.
Index	Lists key terms, acronyms, concepts, and sections in alphabetical order.

Product-Related Documents

Document Number	Document Title
7984-A2-GB20	<i>Hotwire Model 7984 M/HDSL Standalone Termination Unit, with DSX-1 Interface, User's Guide</i>
8000-A2-GB29	<i>Hotwire Management Communications Controller (MCC) Card User's Guide</i>
8600-A2-GN20	<i>Hotwire 8600 Digital Subscriber Line Access Multiplexer (DSLAM) Installation Guide</i>
8784-A2-GZ40	<i>Hotwire 8784 M/HDSL Termination Unit, with DSX-1 Interface, Installation Instructions</i>
8800-A2-GN21	<i>Hotwire 8800 Digital Subscriber Line Access Multiplexer (DSLAM) Installation Guide</i>

Contact your sales or service representative to order additional product documentation.

Most Paradyne documents are also available on the World Wide Web at:

<http://www.paradyne.com>

Select *Service & Support* → *Technical Manuals*

About the Hotwire 8784 Termination Unit

1

M/HDSL Overview

Hotwire™ Multirate High-bit-rate Digital Subscriber Line (M/HDSL) products maximize customer service areas by varying the DSL line rate. This ensures symmetric DSL connectivity over a wide range of telephone line distances and transmission line qualities.

Hotwire products can transport at full (2.048 Mbps) or fractional payload rates over a 4-wire, full-duplex circuit over varying distances based on the conditions of the 4-wire loop. Examples include support for router, multiplexer and PBX connections on 24 gauge (.5 mm) cable up to 21,000 feet (6.4 km).

Hotwire M/HDSL is equipped with an automatic configuration capability that reduces the M/HDSL installation process to a simple plug and play mode. Simply connecting the units to the line automatically configures the customer for the maximum data rate supported by the local loop. M/HDSL units can also be configured at fixed line speeds to achieve maximum distances.

Hotwire 8784 Termination Unit Features

The 2-port Hotwire 8784 M/HDSL Termination Unit is a circuit board mounted in a Hotwire 8600 or 8800 Digital Subscriber Line Access Multiplexer (DSLAM) and used to transport signals at high speeds over a twisted-pair connection.

The 8784 Termination Unit offers these standard features:

- **Embedded Operations Channel (EOC).** Provides remote management via SNMP or Telnet session capability over the M/HDSL network.
- **Asynchronous Terminal Interface (ATI).** Provides a menu-driven VT100-compatible terminal interface for configuring and managing the 8784 Termination Unit locally or remotely by Telnet session.

- **Local Management.** Provides local management using the Management Communications Card (MCC) with a:
 - Terminal or PC via the Management Serial port of the DSLAM
 - NMS connection through the 10BaseT port
 - Network Management System (NMS) via the Management MCC port of the DSLAM
- **Remote Management.** Provides remote management:
 - Out-of-band, using an external modem through the Management Serial port of the DSLAM
 - Via Telnet over the EOC
 - Using SNMP or Telnet through the 10BaseT port or the Internal Management Channel (IMC)
- **Alarm Indication.** Activates front panel LEDs.
- **Diagnostics.** Provides the capability to diagnose device and network problems and perform tests, including digital loopbacks, pattern tests, and self-test.
- **Device and Test Monitoring.** Provides the capability of tracking and evaluating the unit's operation, including health and status, and error-rate monitoring.

Network Configuration

Figure 1-1 shows a T1 network application using an 8784 M/HDSL Termination Unit for access concentration in a central office (CO). A frame relay switch and a router are connected, through the termination unit, to partner units supporting a T1 host or router, and frame relay encapsulated or unframed data.

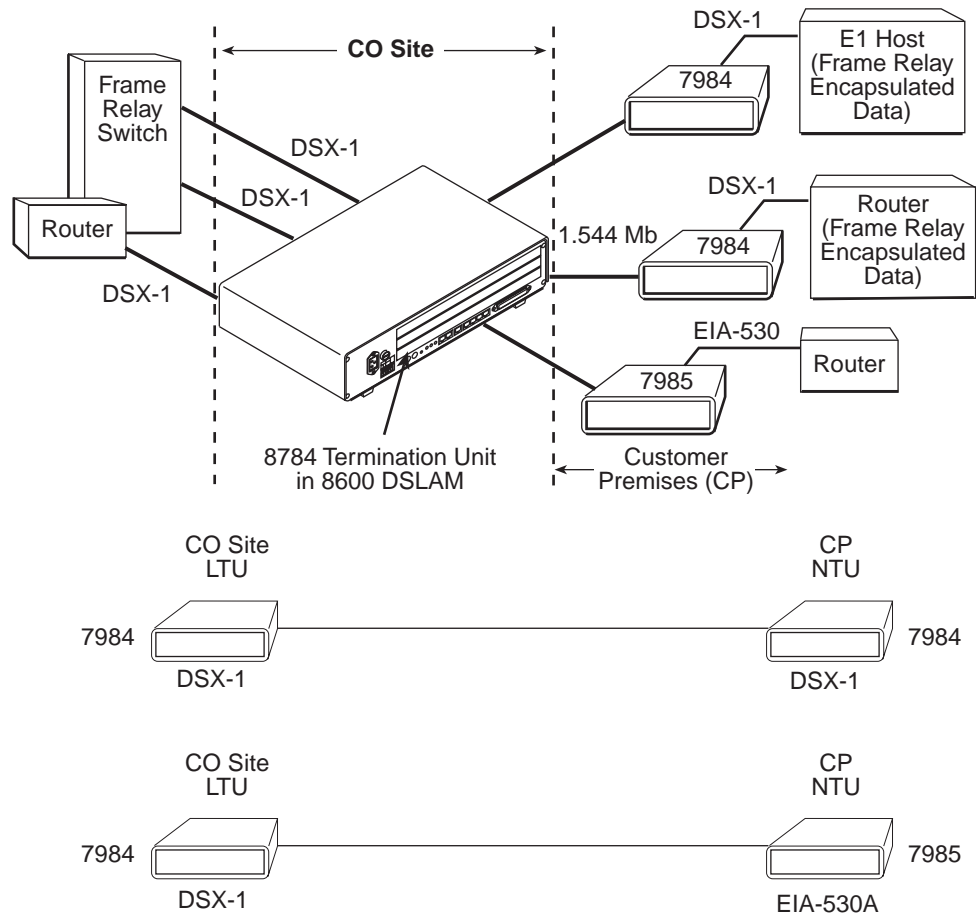

98-16150a

Figure 1-1. Sample Configuration

User Interface Types

There are two types of user interfaces to the 8784 Termination Unit:

- Menu-driven async terminal interface screens. See Chapter 2, *Using the Asynchronous Terminal Interface*.
- Front panel LED status indicators. See Chapter 4, *Monitoring the 8784 Termination Unit*.

SNMP Management Capabilities

The termination unit supports SNMP Version 1, and can be managed by any industry-standard SNMP manager and accessed using SNMP by external SNMP managers.

Management Information Base (MIB) Support

For a detailed description of supported MIBs, visit Paradyne's web site at <http://www.paradyne.com>. The following MIBs are supported:

- **MIB II (RFC 1213 and RFC 1573)** – Defines the general objects for use with a network management protocol in TCP/IP internets and provides general information about the unit. MIB II is backward-compatible with MIB I.
- **DS1/E1 MIB (RFC 1406)** – Reports the performance status of the DSX-1 interface and supports the features found on the DSX-1 Performance Statistics screen.
- **Paradyne Enterprise MIB** – Supports configuration, status, statistics, and tests.

Select Clear to reset a field to a null value.

SNMP Trap Support

The 8784 Termination Unit supports traps as defined in RFC 1215.

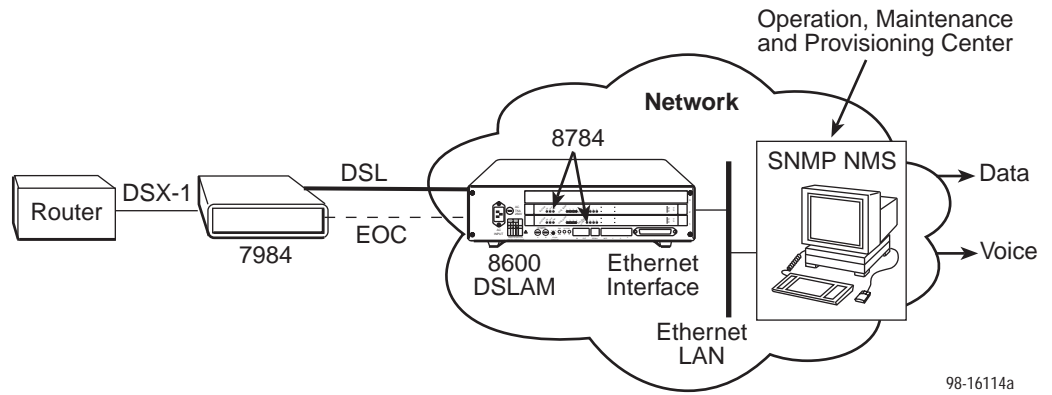

Using the Asynchronous Terminal Interface

2

User Interface Access

You can communicate with the asynchronous terminal interface (ATI) using one of the following methods:

- Direct connection through the Management Serial port of the DSLAM (locally or via an external modem).
- Telnet session using a Network Management System (NMS) connected to a LAN/WAN port on the DSLAM.
- Telnet session through the Embedded Operations Channel (EOC).

NOTE:

Only one asynchronous terminal interface session can be active at a time, and another user's session cannot be forced to end. To automatically log out a user due to inactivity, enable the Inactivity Timeout option (see Table A-5, [Telnet Session Options](#), in Appendix A, *Configuration Option Tables*).

Security can limit ATI access several ways. To set up security or a login ID, refer to Chapter 7, [Security](#).

Management Serial Port Settings

Ensure that the device you connect communicates using these settings:

- Data rate set to 9.6 kbps.
- Character length set to 8.
- Parity set to None.
- Stop Bits set to 1.

Refer to the Installation Guide for your DSLAM.

Logging In to the Hotwire DSLAM

You can log in to the Hotwire DSLAM system using either a local VT100-compatible terminal or a remote Telnet connection. The Hotwire DSLAM system accepts only one login session at a time.

At the Operator Login screen, enter your login ID and password.

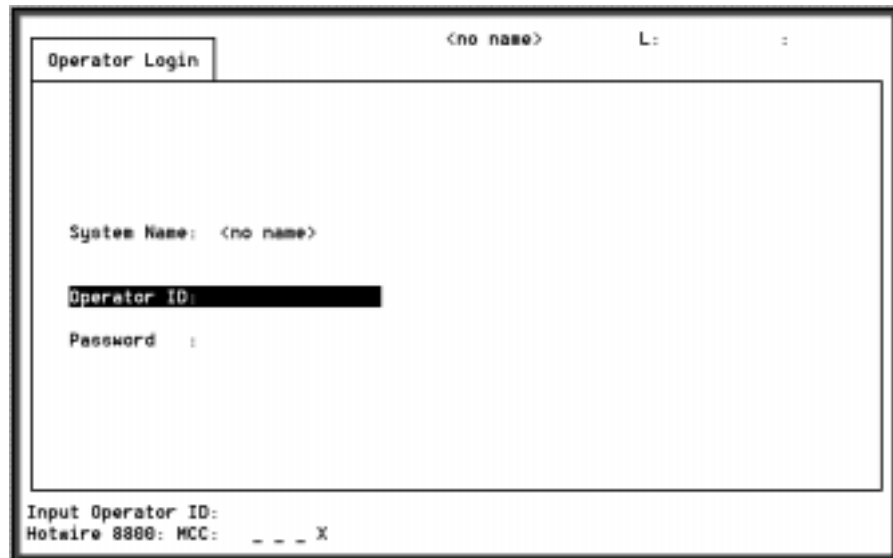

The screenshot shows a terminal window titled "Operator Login". At the top right, it displays "<no name> L: :". The main area contains the following text: "System Name: <no name>", "Operator ID:" followed by a blacked-out input field, and "Password :". At the bottom of the terminal, it shows "Input Operator ID:" and "Hotwire 8880: MCC: _ _ _ X".

NOTE:

The login ID and password are case sensitive; that is, the system recognizes both upper- and lowercase letters. For example, if you enter your user name and password information in upper case letters and your assigned user name and password are in upper- and lowercase letters, the system won't let you log in.

After entering your login ID and password, the system displays the Hotwire Chassis Main Menu.

Selecting the 8784 Card from the DSLAM

From the Hotwire Chassis Main Menu, select Card Selection to display the cards present in the chassis by type and slot number. The Card Selection screen also displays general and interface status for each card.

```

Card Selection                                     <noname>      L:      :
-----
Slit Md1H Stat Eth DSL Lnk WAN Lnk  Slit Md1H Stat Eth DSL Lnk WAN Lnk
M: 8000:  _ _ _ U                    U X X X

4: 8784 :  _                    14: 8784 :  _ M _   X X X X
                    15: 8784 :  _ M _   X X X X

Goto Slot(Card) Number:  █

Goto Card (M for MCC or slot# for DSL):
Hotwire 8000: MCC: 8000:  _ _ _ U

```

► Procedure

To access the 8784 Termination Unit Main Menu screen:

1. From the Hotwire Chassis Main Menu screen, select Card Selection. The Card Selection screen appears.
2. Verify that the card you want to access appears on the Card Selection screen.
3. At the **Goto Card (M for MCC or slot# for DSL):** prompt, enter the number of the slot, then press Enter. For example, if you want to configure the card in Slot 4, enter 4.

The 8784 Termination Unit Main Menu appears.

Initiating an ATI Session

The Main Menu screen is displayed on the screen unless a login ID and password is required or the ATI is already in use.

If security is enabled on the 8784 Termination Unit and you used Telnet to access it directly (you did not log in through the MCC), the system prompts you for a login ID and password.

```
Login                               Hotwire
Slot: 4                             Model: 8784

                                LOGIN

                        Login ID:  _____
                        Enter Password: _____

-----
Ctrl-a to access these functions                                Exit
```

After you enter a valid login ID and password, the Main Menu appears. If you enter an invalid login ID and password after three attempts, the Telnet session closes or the terminal connection returns to an idle state. Refer to Chapter 7, *Security*.

If the ATI is already in use, you will see a **connection refused** or **connection failed** message (if you are using a Telnet session).

```
main                               Access Level: Administrator       Hotwire
Slot: 4                             Model 8784

                                MAIN MENU

                                Status
                                Test
                                Configuration
                                Control

-----
Ctrl-a to access these functions                                Exit
```

Screen Area

Screen Function Keys Area

Entry to all of the termination unit's tasks begins at the Main Menu screen. The four branches of the Main menu are as follows:

Select ...	To ...
Status	View system status, diagnostic test results, statistics, LEDs, and device identity information.
Test	Select, start, stop and cancel tests for the termination unit's interfaces.
Configuration	Display and edit the configuration options.
Control	Change the device identity, administer logins, download new firmware, or initiate a power-up reset of the termination unit.

What appears on the screens depends on your:

- **Current configuration** – How your termination unit is currently configured.
- **Effective security access level** – An access level that is typically set by the system administrator for each interface and each user.
- **Data selection criteria** – What you entered in previous screens.

The following illustration shows the paths to the different ATI screens.

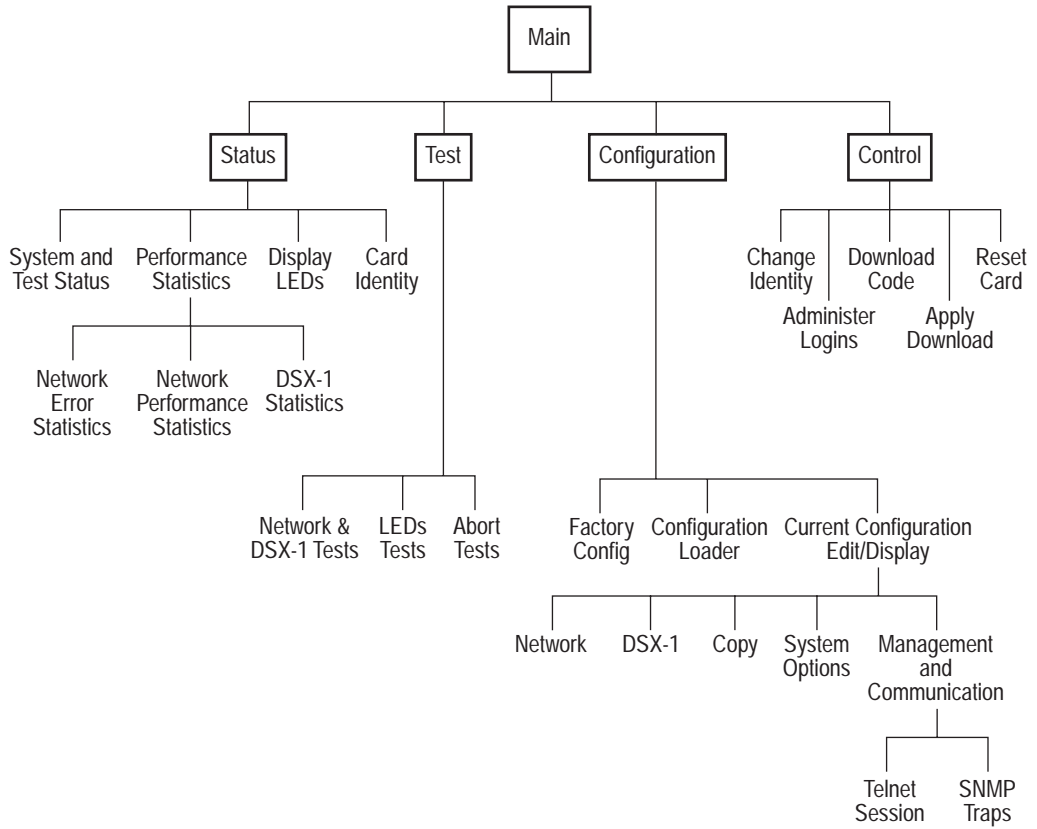

98-15708-01

Screen Work Areas

There are two user work areas:

- Screen area** – This is the area above the dotted line that provides the menu path, menus, and input fields.

The menu path appears as the first line on the screen. In this manual, the menu path is presented as a menu selection sequence with the names of the screens:

Main Menu → Configuration → Load Configuration From → Network Interface Options

- Screen function key area** – This is the area below the dotted line that lists function keys specific to the screen, field value choices, and system messages.

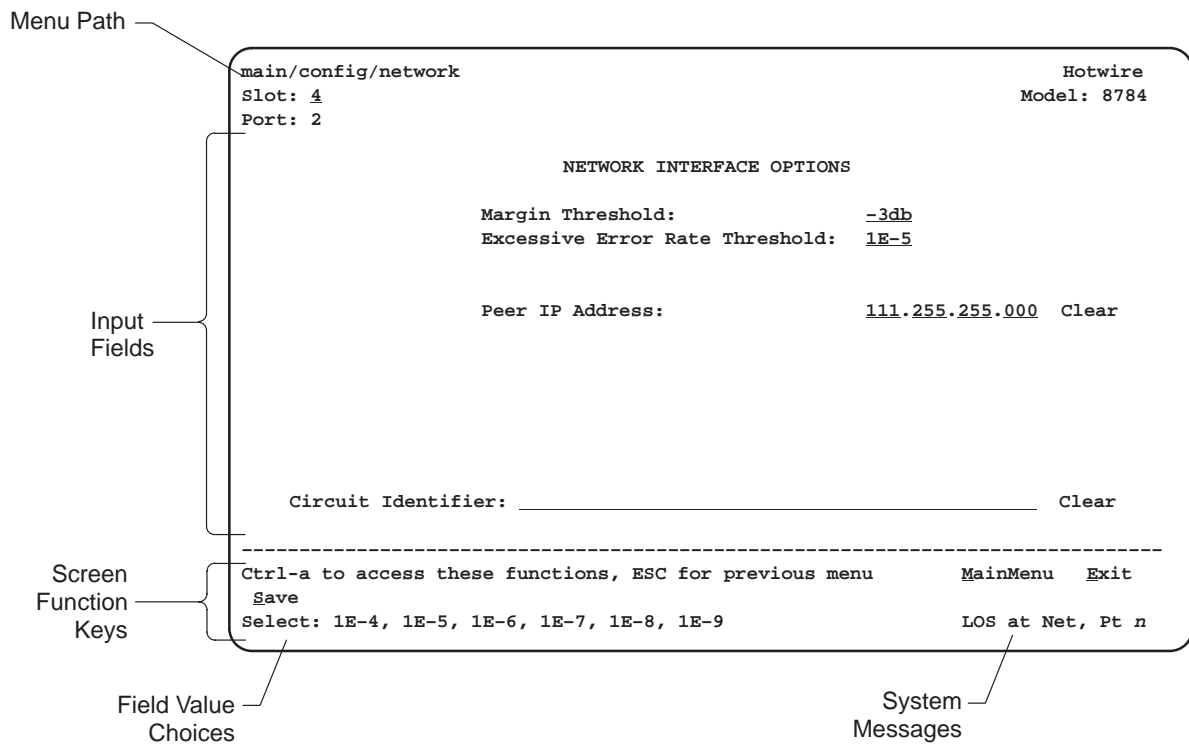

Navigating the Screens

You can navigate the screens by:

- Using keyboard keys
- Using screen function keys
- Switching between the two screen work areas

Keyboard Keys

Use the following keyboard keys to navigate within the screen.

Press . . .	To . . .
Ctrl-a	Move cursor between the screen area and the screen function keys area below the dotted line at the bottom of the screen.
Esc	Return to the previous screen.
Tab	Move cursor to the next field on the screen.
Backspace	Move cursor to the previous field on the screen.
Enter	Accept entry or display valid options on the last row of the screen when pressed before entering data or after entering invalid data.
Ctrl-k	Tab backwards (move cursor one field to the left).
Spacebar	Select the next valid value for the field.
Delete (Del)	Delete character that the cursor is on.
Up Arrow or Ctrl-u	Move cursor up one field within a column on the same screen.
Down Arrow or Ctrl-d	Move cursor down one field within a column on the same screen.
Right Arrow or Ctrl-f	Move cursor one character to the right if in edit mode.
Left Arrow or Ctrl-b	Move cursor one character to the left if in edit mode.
Ctrl-l	Redraw the screen display, clearing information typed in but not yet entered.

► Procedure

To make a menu or field selection:

1. Press the Tab key or the right arrow key to position the cursor on a menu or field selection. Each selection is highlighted as you press the key to move the cursor from position to position.
2. Press Enter. The selected menu or screen appears.
3. Continue Steps 1 and 2 until you reach the screen you want.

The current setting or value appears to the right of the field name. You can enter information into a selected field by:

- Typing in the first letter(s) of a field value or command.
- Switching from the screen area to the screen function area below the dotted line and selecting or entering the designated screen function key.

If a field is blank and the Field Values screen area displays valid selections, press the spacebar and the first valid value for the field will appear. Continue pressing the spacebar to scroll through other valid values.

Screen Function Keys

All screen function keys located below the dotted line operate the same way (upper- or lowercase) throughout the screens.

For the screen function . . .	Select . . .	And press Enter to . . .
Clr <u>F</u> ar	F or f	Clear far-end network statistics and refresh the screen.
Clr <u>N</u> ear	N or n	Clear near-end network statistics and refresh the screen.
Clr <u>S</u> tats	S or s	Clear G.703 statistics and refresh the screen.
De <u>l</u> ete	L or l	Delete data.
<u>E</u> xit	E or e	Terminate the async terminal session.
<u>M</u> ainMenu	M or m	Return to the Main Menu screen.
<u>N</u> ew	N or n	Enter new data.
Pg <u>D</u> n	D or d	Display the next page, or group of entries.
Pg <u>U</u> p	U or u	Display the previous page, or group of entries.
<u>R</u> esetMon	R or r	Reset an active Monitor 511 test counter to zero.
<u>S</u> ave	S or s	Save information.

Switching Between Screen Work Areas

Select Ctrl-a to switch between the two screen work areas to perform all screen functions.

► Procedure

To access the screen function area below the dotted line:

1. Press Ctrl-a to switch from the screen area to the screen function key area below the dotted line.
2. Select either the function's designated (underlined) character or press the Tab key until you reach the desired function key.

Example:

To save the current options, type **s** or **S** (Save).

3. Press Enter. The function is performed.
4. To return to the screen area above the dotted line, press Ctrl-a again.

```
main/config/network                               Hotwire
Slot: 4                                           Model: 8784
Port: 2

                                NETWORK INTERFACE OPTIONS

Margin Threshold:                               -3db
Excessive Error Rate Threshold: 1E-5

Peer IP Address:                               111.255.255.000 Clear
Circuit Identifier: _____ Clear

-----
Ctrl-a to access these functions, ESC for previous menu      MainMenu  Exit
```

Ending an ATI Session

Use the Exit function key from any screen to terminate the session.

► Procedure

To end a session with the asynchronous terminal interface:

1. Press Ctrl-a to go to the screen function key area below the dotted line.
2. Save changes if required. A confirmation message appears if you have made but not saved changes to your configuration.
3. Tab to Exit (or type **e** or **E**) and press Enter. If you have accessed the card through the MCC, the Hotwire Chassis Card Selection menu appears.

Exiting From the DSLAM Session

You can manually log out of the system or, after five minutes of inactivity, the system will automatically log you out.

► Procedure

To manually exit from the Hotwire DSLAM system:

1. Return to the Hotwire Chassis Main Menu by selecting Exit from either the Hotwire – MCC menu or the Hotwire – DSL menu.
The Hotwire Card Selection menu appears.
2. Press Ctrl-z.
The Hotwire Chassis Main Menu appears.
3. From the Hotwire Chassis Main Menu, select Logout.
The system exits from the current login session on the Hotwire DSLAM.

Initial Startup and Configuration

3

Overview

This chapter provides instructions on how to access the system for the first time and perform initial setup procedures. These procedures include:

- Providing initial unit identity information or changing existing identity information.
- Configuring your unit using the Configuration Edit menus.
- Choosing the current or factory default configuration options or downloading configuration options from a TFTP server.
- Modifying current configuration options using the Configuration Edit/Display menu.
- Saving your changes.
- Downloading unit firmware from a TFTP server.

Entering Identity Information

After accessing your unit for the first time, use the Change Identity screen to determine SNMP administrative system information that will be displayed on the Identity screen of the Status branch. To access the Card Identity screen, follow this menu selection sequence:

Main Menu → Control → Change Identity

```
main/control/change_identity                               Hotwire
Slot: 4                                                  Model: 8784

                                IDENTITY

System Name:      111QJ98-001_____ Clear
System Location: Bldg. A412, 2nd Floor, Left cabinet_____ Clear
System Contact:  C. Parker 800-727-2396 pager 888-555-1212 Clear

-----
Ctrl-a to access these functions, ESC for previous menu   MainMenu  Exit
Save
```

The three System entry fields are alphanumeric and provide 128 characters for each field. The System entries appear on the Identity display as shown above. The SNMP System entry fields are:

- **System Name:** The general SNMP system name.
- **System Location:** The physical location of the SNMP-managed device.
- **System Contact:** Identification information, such as contact name, phone number, or mailing address.

Valid entry values are any printable ASCII character. ASCII printable characters include:

- Numeric 0–9
- Upper or lower case A–Z
- Space
- All ASCII symbols except the caret (^)

► Procedure

To enter Change Identity screen information:

1. Position the cursor in the System Name field. Enter a name unique in your network to identify the SNMP managed node (or unit)
The maximum length of System Name is 128 characters.
2. Position the cursor in the System Location field. Enter the physical location of the unit.
The maximum length of System Location is 128 characters.
3. Position the cursor in the System Contact field. Enter the name and contact information for the person responsible for the unit.
The maximum length of System Contact is 128 characters.
4. Press Ctrl-a to switch to the screen function key area below the dotted line.
5. Select Save and press Enter.

Configuring the 8784 Termination Unit

Configuration option settings determine how the 8784 Termination Unit operates. Use the Configuration branch of the 8784 Termination Unit menu to display or change configuration option settings.

Configuration Options

The 8784 Termination Unit is shipped with factory settings in the Default Factory Configuration area. You can find default information by:

- Referring to Appendix A, *Configuration Option Tables*.
- Accessing the Configuration branch of the 8784 Termination Unit menu.

The 8784 Termination Unit has two sets of configuration option settings. The Current Configuration matches the Default Factory Configuration until modified and saved by the user.

Configuration Option Area	Configuration Option Set
Current Configuration	The 8784 Termination Unit's active set of configuration options.
Default Factory Configuration	A read-only configuration area containing the factory default configuration options.

If the factory default settings do not support your network's configuration, customize the configuration options for your application.

Accessing and Displaying Configuration Options

To display the configuration options, you must first load a configuration option set into the edit area.

To load a configuration option set into the configuration edit area, follow this menu selection sequence:

Main Menu → Configuration (Load Configuration From)

```

main/configuration                               Hotwire
Slot: 4                                         Model: 8784

                                LOAD CONFIGURATION FROM:

                                Current Configuration
                                Configuration Loader
                                Default Factory Configuration

-----
Ctrl-a to access these functions, ESC for previous menu      MainMenu  Exit

```

Make a selection by placing the cursor at your choice and pressing Enter.

If you select ...	Then ...
Current Configuration	The selected configuration option set is loaded and the Configuration Edit/Display menu screen appears.
Default Factory Configuration	The default factory configuration is loaded and the Configuration Edit/Display menu screen appears.
Configuration Loader	The Configuration Loader screen is displayed allowing you to upload or download configurations from a TFTP server.

Configuration Edit/Display

The Configuration Edit/Display screen is displayed when the current, customer, or default configuration is loaded and allows groups of configuration options to be displayed. To access the Configuration Edit/Display screen, follow this menu selection sequence:

Main Menu → Configuration → Current Configuration

– or –

Main Menu → Configuration → Default Factory Configuration

```

main/config/edit                               Hotwire
Slot: 4                                       Model: 8784

                                CONFIGURATION EDIT/DISPLAY

                                Network
                                DSX-1
                                Copy Ports
                                System Options
                                Management and Communication

-----
Ctrl-a to access these functions, ESC for previous menu      MainMenu  Exit
Save
  
```

Select ...	To Access the ...	To Configure the ...
Network	Network Interface Options , Table A-1	T1 HDSL network interface Ports 1–4.
DSX-1	Synchronous Data Port Options , Table A-2	DSX-1 interface Ports 1–4.
Copy Ports	Copy Port Options , Table A-3	T1 HDSL network and DSX-1 interface ports by copying options from port to port.
System Options	System Options , Table A-4	General system options of the unit.
Management and Communication	<ul style="list-style-type: none"> ■ Telnet Session Options, Table A-5 ■ SNMP Traps Options, Table A-6 ■ General SNMP Management Options, Table A-7 ■ SNMP NMS Security Options, Table A-8 	Management support of the unit through SNMP and Telnet.

Configuration Loader

The Configuration Loader screen allows you to upload configurations to and download configurations from a TFTP server. To access the Configuration Loader screen, follow this menu selection sequence:

Main Menu → Configuration → Configuration Loader

```

main/config/config_loader                               Hotwire
Slot: 4                                                Model: 8784

                                CONFIGURATION LOADER

Image File Name: _____ Clear
TFTP Server IP Address: 000.000.000.000 Clear
TFTP Transfer Direction: Download from Server
Destination: DSL1

Start Transfer: Yes

Packets Sent: 0000000
Packets Received: 0000000
Bytes Sent: 0000000
Bytes Received: 0000000
Transfer Status: Transfer Pending

Activate new configuration? No

-----
Ctrl-a to access these functions, ESC for previous menu      MainMenu Exit

```

► Procedure

To upload or download a configuration:

1. Position the cursor in the Image File Name field. Type the name of the file to be downloaded, or the name to be used for the file to be uploaded.

The file name may be a regular path name expression of directory names separated by a forward slash (/) ending with the file name. The total path name length can be up to 128 characters.

DOS machine: If the TFTP server is hosted by a DOS machine, then directory and file names must consist of eight or less characters with an optional suffix of up to three characters. The system will automatically upload the configuration file and create directories and file names as needed.

UNIX machine: If your server is hosted by a UNIX machine, the configuration file you name must already exist. It will not be created on the UNIX system by the TFTP server. It is critical that you work with your system administrator to plan the naming conventions for directories, filenames, and permissions so that anyone using the system has read and write permissions.

2. Position the cursor in the TFTP Server IP Address field. Enter the TFTP server IP address.

The first three digits of the IP address cannot be 000 or greater than 223.

3. Position the cursor in the TFTP Transfer Direction field. Use the spacebar to select Download from Server or Upload to Server.
4. Position the cursor in the Destination field. Use the spacebar to select a network destination for the TFTP server. Select DSL if the TFTP server destination is the DSL link port or IMC (in-band management channel) if the TFTP destination is the Management port of the MCC.
5. Position the cursor at the Start Transfer field. Use the spacebar to select Yes. Press Enter.

When the data transfer is complete, the Transfer Status field changes to **Completed successfully**.

6. Position the cursor at the Activate new configuration? field and select Yes to activate a new downloaded configuration. Press Enter.

NOTE:

The following options are not changed:

- DSL Mode and Telnet Session configuration options
- Peer IP address

You must change these settings with the appropriate configuration menus after the new configuration is activated. See Table A-1, [Network Interface Options](#), Table A-4, [System Options](#), and Table A-5, [Telnet Session Options](#), in Appendix A, *Configuration Option Tables*.

Saving Configuration Options

When changes are made to the configuration options through the Configuration Edit/Display branch, the changes must be saved to take effect. Use the Save key or Save Configuration screen.

► Procedure

To save configuration options changes:

1. Press Ctrl-a to switch to the screen function key area below the dotted line.
2. Select Save and press Enter.

NOTE:

When Exit is selected before Save, or Save has been selected from any menu in the Configuration/Edit branch, a Save Configuration screen appears requiring a Yes or No response.

```

main/config/saveprompt                               Hotwire
Slot: 4                                             Model: 8784

                SAVE CONFIGURATION

                Save Changes? No_

                WARNING:

                An answer of "yes" will cause the system
                to reset as if it had been powered off and on!

-----
Ctrl-a to access these functions, ESC for previous menu      MainMenu  Exit
Command Complete

```

If the Telnet Session configuration option is changed, a message displays on the Save Configuration screen warning that an answer of Yes will cause the Telnet session to disconnect. Do not answer Yes unless you are prepared to disconnect.

If the HDSL Mode configuration option is changed, the Save Configuration screen bears the warning that an answer of Yes will cause the system to reset. Do not answer Yes unless you are prepared to reset.

If you select ...	Then ...
Yes	The configuration is saved.
No	The Main Menu appears and changes are not saved.

Restoring Access to the User Interface

Improper configuration of the 8784 Termination Unit could render the user interface inaccessible. If this occurs, access can be restored using the MCC.

► Procedure

To reset the DSL Card:

1. Select *Configuration* → *DSL Cards* → *Reset Slot*.
2. Enter **DSLnn**, where *nn* is the slot number for the DSL card you wish to reset.
3. Enter **Reset**.
4. Enter **Y** if you want to clear NVRAM also, otherwise enter **N**.
5. Enter **Y** at the prompt to confirm.

NOTE:

When you enter **Y**, all data connectivity is interrupted.

Download Code

The Download Code screen allows you to download firmware from a TFTP server. To access the Download Code screen, follow this menu selection sequence:

Main Menu → *Control* → *Download Code*

```

main/control/download_code                               Hotwire
Slot: 4                                                  Model: 8784

                                DOWNLOAD CODE

      Image File Name: _____ Clear
TFTP Server IP Address: 000.000.000.000                Clear
      Destination: DSL1

      Start Transfer: Yes

      Packets Sent: 0000000
      Packets Received: 0000000
      Bytes Sent: 0000000
      Bytes Received: 0000000
      Transfer Status: Transfer Pending

-----
Ctrl-a to access these functions, ESC for previous menu      MainMenu  Exit

```

► **Procedure**

To download firmware:

1. Position the cursor in the Image File Name field. Type the name of the file to be downloaded.

The file name may be a regular path name expression of directory names separated by a forward slash (/) ending with the file name. The total path name length can be up to 128 characters.

2. Position the cursor in the TFTP Server IP Address field. Enter the TFTP server IP address.

The first three digits of the IP address cannot be 000 or greater than 223.

3. Position the cursor at the Start Transfer field. Use the spacebar to select Yes. Press Enter.

When the data transfer is complete, the Transfer Status field changes to **Completed successfully**.

4. Press the Escape key to return to the Control menu. Select Apply Download.

5. On the Apply Download screen, type **Yes** to reset the card and activate the code.

Monitoring the 8784 Termination Unit

4

What to Monitor

This chapter presents information on how to access and monitor 8784 Termination Unit status and performance statistics on the network. You can monitor 8784 Termination Unit operations by viewing:

- System and Test Status screen
- Highest priority Health and Status message on the last line of all screens
- Network Error Statistics screen
- Network Performance Statistics screen
- DSX-1 Statistics screen
- Display Card LEDs screen or LEDs on the 8784 Termination Unit's front panel

Viewing System and Test Status

To view System and Test Status information, follow this menu selection sequence:

Main Menu → Status → System and Test Status

```

main/status/system
Slot: 2
Hotwire
Model: 8784
SYSTEM AND TEST STATUS
Page 1 of 1
HEALTH AND STATUS      SELF-TEST RESULTS      TEST STATUS
-----
LOS at Net, Pt n       CPU Failed              No Test Active
OOF at Net, Pt n       Device Failed           LLB Test Active, Pt n
EER at Net, Pt n       Net DSL Failed, Pt n   RLB Test Active, Pt n
LOS at DSX-1 Pt n     DSX-1 Pt Failed, Pt n  Lamp Test Active
Net Margin Threshold, Pt n  Memory Failed          DLB Test Active, Pt n
Device Failed yyyyyyy   Passed
Download Failed
-----
ESC for previous menu   MainMenu  Exit

```

The System and Test Status screen has three sections:

- **Health and Status** – Displays messages in priority order (highest to lowest). Refer to Table 4-1, [Health and Status Messages](#).
- **Self-Test Results** – Results of the Diagnostic test run on the device itself. Refer to Table 4-2, [Self-Test Results Messages](#).
- **Test Status** – Currently active tests. Refer to Table 4-3, [Test Status Messages](#).

Health and Status

The following messages appear in the first column of the System and Test Status screen. The highest priority Health and Status message also appears on all ATI screens on the bottom right.

Table 4-1. Health and Status Messages (1 of 2)

Message	What Message Indicates	What To Do
System Operational	There are no problems detected.	
LOS at Net, Pt <i>n</i>	An LOS (Loss Of Signal) condition has been detected on the network interface. No signal is being received on Port <i>n</i> , possibly due to a local network problem.	<ol style="list-style-type: none"> 1. Verify that the network cable is securely attached at both ends. 2. Contact network provider.
OOF at Net, Pt <i>n</i>	Three consecutive frame synchronization bits were in error.	<ol style="list-style-type: none"> 1. Check the Transmit Clock Source configuration options. Do not set both the local and remote unit to Internal, External, or Loop timing. 2. Contact network provider.
EER at Net, Pt <i>n</i>	An EER (Excessive Error Rate) condition has been detected on the network interface at Port <i>n</i> . The condition is cleared when the error rate falls below the threshold value currently configured.	Contact network provider.
NTU/LTU Mis match, Pt <i>n</i>	The NTU is not configured the same as the LTU.	Configure units to match.
LOS at DSX-1, Pt <i>n</i>	An LOS (Loss Of Signal) condition has been detected on the DSX-1 interface. No signal is being received on Port <i>n</i> .	Verify that the interface cable is securely attached at both ends.
LOF at DSX-1, Pt <i>n</i>	An LOF (Loss Of Frame) condition has been detected on the DSX-1 interface.	<ol style="list-style-type: none"> 1. Verify that the network cable is securely attached at both ends. 2. Contact network provider.
AIS at DSX-1, Pt <i>n</i>	An Alarm Indication Signal (AIS) is being received by the DSX-1 interface.	<ol style="list-style-type: none"> 1. Verify that the units line framing and line coding are compatible. 2. Contact network provider.
EER at Net, Pt <i>n</i>	An EER (Excessive Error Rate) condition has been detected on the network interface at Port 1. The condition is cleared when the error rate falls below the threshold value currently configured.	<ol style="list-style-type: none"> 1. Ignore condition if 511 test active. 2. Contact network provider.

Table 4-1. Health and Status Messages (2 of 2)

Message	What Message Indicates	What To Do
EER at DSX-1, Pt <i>n</i>	An EER (Excessive Error Rate) condition has been detected on the DSX-1 interface.	<ol style="list-style-type: none"> 1. Verify the attached equipment coding is compatible. 2. Contact network provider.
Yellow alarm at DSX-1, Pt <i>n</i>	A Yellow Alarm Indication signal is being received by the DSX-1 interface.	<ol style="list-style-type: none"> 1. Verify that the units line framing and line coding are compatible. 2. Contact network provider.
Net Margin Threshold, Pt <i>n</i>	The signal-to-noise margin has exceeded the configured threshold.	<ol style="list-style-type: none"> 1. Reconfigure the unit to a higher Net Margin Threshold. 2. Contact network provider.
Primary Clock Failed (DSX-1, Pt <i>n</i>)	A failure has occurred in the primary clock source configured from the Network, DSX, or from the card internal clock.	<ol style="list-style-type: none"> 1. Verify that the network cable is securely attached at both ends. 2. Contact network provider.
Device Failed <i>yyyyyyyy</i>	An internal error has been detected by the operating software. <i>yyyyyyyy</i> indicates the 8-digit hexadecimal failure code.	<ol style="list-style-type: none"> 1. Provide the 8-digit failure code shown (<i>yyyyyyyy</i>) to your service representative. 2. Reset the 8784 Termination Unit to clear the condition and message.
Download Failed	A firmware download was interrupted.	Repeat the download.
Net Com Link Down	The Network communication link is down. Communications between the management system and the LTU/NTU is not possible.	<ol style="list-style-type: none"> 1. Verify that the network cable is securely attached at both ends. 2. Verify the link protocol for the COM port is configured correctly.

Self-Test Results

The results of the last power-up or reset self-test appear in the middle column of the System and Test Status screen.

Table 4-2. Self-Test Results Messages

Message	What Message Indicates	What To Do
CPU Failed	The CPU failed internal testing.	1. Reset the unit and try again.
DeviceFailed	One or more of the 8784 Termination Unit's integrated circuit chips has failed device-level testing.	2. Call your service representative for assistance.
Net DSL Failed, Pt <i>n</i>	The 8784 Termination Unit failed to loop data on the network DSL circuit of Port <i>n</i> .	1. Reset the unit and try again. 2. Call your service representative for assistance.
DSX-1 Failed, Pt <i>n</i>	The 8784 Termination Unit failed to internally loop data on the DSX-1 Port <i>n</i> .	1. Reset the unit and try again. 2. Call your service representative for assistance.
Memory Failed	The 8784 Termination Unit failed memory verification.	1. Reset the unit and try again. 2. Call your service representative for assistance.
Failure xxxxxxx	An internal failure occurred. (xxxxxxx represents an 8-digit hexadecimal failure code for use by service personnel.)	Record the failure code and contact your service representative.
Passed	No errors were detected.	N/A

Test Status

The **Test Status messages** in the following table appear in the right column of the System and Test Status screen.

Table 4-3. Test Status Messages

Test Status Message	Meaning
No Test Active	No tests are currently running.
LLB Test Active, Pt <i>n</i>	A network Line Loopback test is active on Port <i>n</i> .
RLB Test Active, Pt <i>n</i>	A network Repeater Loopback test is active on Port <i>n</i> .
DLB Test Active, Pt <i>n</i>	A Data Terminal Loopback test is active on Port <i>n</i> .
511 Test Active, Pt <i>n</i>	A 511 Test and Monitor is active on the DSL Port <i>n</i> network interface.
Lamp Test Active	The Lamp Test is active, causing the LEDs on the front panel to light.

Viewing Network Error Statistics

The 8784 Termination Unit maintains error statistics on the network DSL interface for each port. Port 1 is the default screen selection.

Statistics are maintained for up to 96 15-minute intervals (24 hours).

To view the Network Error Statistics, follow this menu selection sequence:

Main Menu → *Status* → *Performance* → *Network Error Statistics*

```

main/status/performance/net_error                               Hotwire
Slot: 4:                                                         Model: 8784
Port: 3                                                         NETWORK ERROR STATISTICS

Current Interval Timer: 2                                       Error Events Counter: 34
-----
      ---ES---          ---SES---          --FEBE--          -Complete-
        Near Far          Near Far          Near Far          Near Far
Current Int: 000 000          000 000          000 000          Yes No
Interval 01 000 000          000 000          000 000          Yes Yes
Interval 02 000 000          000 000          000 000          Yes Yes
Interval 03 000 000          000 000          000 000          Yes Yes
Interval 04 000 000          000 000          000 000          Yes Yes
Interval 05 000 000          000 000          000 000          Yes Yes
Interval 06 000 000          000 000          000 000          Yes Yes
Interval 07 000 000          000 000          000 000          Yes Yes

Worst Interval: 24 09          14 08          18 18
Near Tot(valid): 00010          00000          00000
Far Tot(valid): 00010          00000          00000
-----
Ctrl-a to access these functions, ESC for previous menu      MainMenu  Exit
PgUp      PgDn      ClrNear  ClrFar

```

Select a port 1–4 to view error statistics for the port. The default port is 1. Use the virtual function keys to page through the intervals and clear statistics.

Network Error Statistics are collected for all ports for:

- **ES (Errored Seconds):** Seconds during which one or more ESF error events occurred.
- **SES (Severely Errored Seconds):** Seconds during which more than 320 cyclic redundancy check (CRC) error events or at least one Out of Frame (OOF) event occurred.
- **FEBE (Far-End Block Errors):** Errors reported by the remote equipment.
- **Complete:** Whether the interval register contains data for all 900 seconds of the interval.

Use the virtual function keys to page through the intervals and clear statistics.

This Field . . .	Contains . . .
Current Interval Timer	The number of seconds which have elapsed in the current 15-minute interval. Maximum value is 900 seconds (15 minutes). This counter resets every 15 minutes.
Error Events Counter	A running total of CRC errors. Range 0–65535. This counter resets when the near-end data is cleared.
Current Interval	Performance data for the current 15 minutes.
Interval xx	Historical performance data for up to 96 15-minute intervals (24 hours).
Worst Interval	The number of the interval with the worst (highest) performance data for both the near- and far-end statistics. If two or more intervals are equal, the oldest interval is displayed.
Near and Far TOT	A running total of the near- and far-end performance statistics.

Viewing Network Performance Statistics

Network performance statistics allow you to monitor the current status of the network DSL operations. Performance statistics can assist you in determining the duration of specific conditions and provide a historical context for problem detection and analysis.

Statistics are maintained for up to 96 15-minute intervals (24 hours).

To view the Network Performance Statistics, follow this menu selection sequence:

Main Menu → Status → Performance → Network Performance Statistics

```

main/status/performance/net_perf                               Hotwire
Slot: 4:                                                       Model: 8784
Port: 2                NETWORK PERFORMANCE STATISTICS
                        Payload Rate: 1536 kbps
                        DSL Line Rate: 1552 kbps
Current Interval Timer: 002
-----
--Mrgn--      --XmtPw-      --RxGn--      -Complete-
  Near Far      Near Far      Near Far      Near Far
Current Int: +02 +01      +03 +03      +02 +02      Yes Yes
Interval 01 +02 +02      +03 +03      +02 +02      Yes No
Interval 02 +02 +01      +03 +03      +02 +02      Yes Yes
Interval 03 +02 +01      +03 +03      +02 +02      Yes Yes
Interval 04 +02 +01      +03 +03      +02 +02      Yes Yes
Interval 05 +02 +01      +03 +03      +02 +02      Yes Yes
Interval 06 +02 +01      +03 +03      +02 +02      Yes Yes
Interval 07 +02 +01      +03 +03      +02 +02      Yes Yes
-----
Ctrl-a to access these functions, ESC for previous menu      MainMenu  Exit
PgUp      PgDn      ClrNear  ClrFar

```

Select a port (1–4) to view performance statistics for the port. The default port is 1. Use the virtual function keys to scroll through the intervals and clear statistics.

Use the virtual function keys to scroll through the intervals and clear statistics.

Network Performance Statistics are collected for all ports for:

- **Mrgn:** Margin, the signal-to-noise ratio (SNR) less an SNR reference value.
- **XmtPw:** The transmit power level.
- **RxGn:** The receiver gain level.
- **Complete:** Whether the interval register contains data for all 900 seconds of the interval.

This Field . . .	Contains . . .
Current interval timer	The number of seconds which have elapsed in the current 15-minute interval. Maximum value is 900 seconds (15 minutes). This counter resets every 15 minutes.
DSL Line Rate	The rate of the DSL line (1552).
Payload Rate	The rate of data transfer.
Current Interval	Performance data for the current 15 minutes.
Interval xx	Historical performance data for up to 96 15-minute intervals (24 hours).

Viewing DSX-1 Performance Statistics

DSX-1 performance statistics allow you to monitor the current status of the DSX-1 interface operations when ESF framing is selected. Performance statistics can assist you in determining the duration of specific conditions and provide a historical context for problem detection and analysis. Statistics are maintained for up to 96 15-minute intervals (24 hours).

To view the Network Performance Statistics, follow this menu selection sequence:

Main Menu → Status → Performance → DSX-1 Performance Statistics

```

main/status/performance/DSX-1                               Hotwire
Slot 4                                                       Model: 8784
                    DSX-1 PERFORMANCE STATISTICS

Current Interval Timer: 2                                Error Events Counter: 0000
-----
--ES--  --UAS--  --SES--  --BES--  --LOFC--  -Status-
Current Int:  000    000    000    000    000    Y
Interval 01  000    000    000    000    000    none
Interval 02  000    000    000    000    000    none
Interval 03  000    000    000    000    000    none
Interval 04  000    000    000    000    000    none
Interval 05  000    000    000    000    000    none
Interval 06  000    000    000    000    000    none
Interval 07  000    000    000    000    000    none

Worst Interval: 24      14      14      09      18
Tot (valid 96):00010   00000   00000   00000   002
-----
Ctrl-a to access these functions, ESC for previous menu      MainMenu  Exit
PgUp    PgDn    ClrStats

```

Select PgUp or PgDn to view the next or previous seven intervals, select ClrStats to clear all statistics to zero.

DSX-1 Performance Statistics are collected for:

- **ES (Errored Seconds):** Seconds during which one or more error events occurred.
- **UAS (Unavailable Seconds):** Seconds during which service is unavailable. UAS is received at the start of 10 consecutive SES and cleared at the start of 10 seconds with no SES.
- **SES (Severely Errored Seconds):** Seconds during which 320 or more cyclic redundancy check (CRC) error events or at least one Out of Frame (OOF) event occurred.
- **BES (Bursty Errored Seconds):** Contains the number of bursty errored seconds for the current interval. A bursty errored second is any second with more than one but less than 320 CRC errors.
- **LOFC (Loss of Frame Count):** Contains the number of times that an LOF is declared.

- **Status:** Contains the contents of the status events register. The status events register maintains a history of specific events that have occurred during an interval. Values include:
 - Y – Remote alarm indication signal (yellow alarm) received at the DSX-1 interface
 - L – Loss of signal detected at the DSX-1 interface
 - E – Excessive error rate threshold exceeded
 - F – Frame synchronization bit error detected
 - V – Line code violation detected
 - None – No significant events have occurred

This Field . . .	Contains . . .
Current interval timer	The number of seconds which have elapsed in the current 15-minute interval. Maximum value is 900 seconds (15 minutes). This counter resets every 15 minutes.
Current Interval	Performance data for the current 15 minutes.
Interval xx	Historical performance data for up to 96 15-minute intervals (24 hours) where the value of xx is from 01 to 96.
Error Events Counter	A running total of CRC and OOF events. Total range = 0–65535. Counter resets when the statistics are cleared.

Viewing 8784 Termination Unit LEDs

The 8784 Termination Unit LEDs can be viewed on the Display LEDs Status screen. This ATI status screen is available locally and remotely.

The 11 LEDs are organized into three groups:

- **General** LEDs display the status of the unit
- **DSX-1** LEDs provide the status of the DSX-1 interface
- **DSL Loop** LEDs display the activity on the DSL network

To view the Display LEDs status screen, follow this menu selection sequence:

Main Menu → Status → Display LEDs

```
main/status/leds                                     Hotwire
                                                    Model: 8784

                DISPLAY LEDs

        GENERAL                DSX-1                DSL LOOP
-----
        ALRM:Off              P1:Link Up             P1:Lnk Up
        TEST On

-----
                                ESC for previous menu      MainMenu  Exit
```

The LED status display screen is updated every 5 seconds. For information about the meaning of 8784 Standalone Termination Unit LEDs, see *8784 Termination Unit LEDs* on page 4-13.

8784 Termination Unit LEDs

The following table describes the meaning and states of the LEDs on the 8784 Termination Unit faceplate.

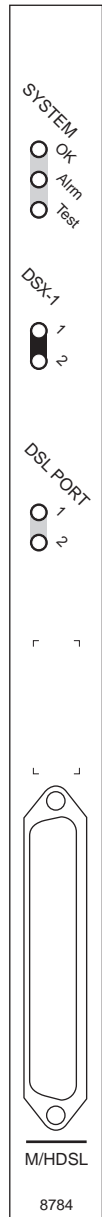

98-16144a

Type	LED	LED is . . .	Indicating . . .
SYSTEM	OK	Green Off	Normal operation; card functioning normally. No power to card, or card failure.
	Alarm	Amber Off	Device failure, or Power-On Self Test (POST) is not complete. No alarms.
	Test	Amber Amber, flashing Off	Loopback test or 511 test pattern in progress. POST in progress. No tests.
DSX-1	1, 2	Green	Recoverable signal present on the DSX-1 network.
		Amber	Yellow Alarm Indication (RAI) present.
		Amber, flashing	An LOF or AIS condition exists.
		Off	The DSL LINK is down.
DSL PORT	1, 2	Green	DSL link is up.
		Off	DSL link is down.
		Amber	DSL training in progress.
		Amber, flashing	OOF condition.

Testing

5

Accessing the Test Menu

From the Test menu, you can run network tests, data port tests, and a front panel lamp test.

To access the Test menu, follow this menu selection sequence:

Main Menu → Test

```
main/test Hotwire  
Model: 8784  
  
TEST  
Network & DSX-1 Tests  
Device Tests  
Abort Tests  
  
-----  
Ctrl-a to access these functions, ESC for previous menu MainMenu Exit
```

Select ...	To ...
Network and DSX-1 Tests	Start and stop tests on the DSX-1 or network interface.
Device Tests	Start and stop lamp test.
Abort Tests	To abort current tests excluding Network-initiated loopback tests. An aborted test may continue to run for a few seconds as the abort command is sent to the remote end and processed.

Running Network Tests

Network tests require the participation of your network service provider. To access the Network Tests screen, follow this menu selection sequence:

Main Menu → Test → Network & DSX Tests

```

main/test/network_DSX                                     Hotwire
                                                         Model: 8784

                                NETWORK & DSX TESTS

Test          Command  Status   Results
-----
Local Loopbacks
  Line Loopback:      Start   Inactive  00:00:00
  Repeater Loopback:  Start   Inactive  00:00:00
  DTE Loopback:       Start   Inactive  00:00:00

Remote Loopbacks
  Send Line Loopback: Down  Send    Inactive  00:00:00

Pattern Tests
  Send and Monitor 511  Stop    Active    hh:mm:ss - Errors 99999+

-----
Ctrl-a to access these functions, ESC for previous menu      MainMenu  Exit
ResetMon

```

Use the **Command** column to start or stop a test. When the **Status** column shows that a test is Inactive, Start is displayed; when a test is Active, Stop is displayed. Position the cursor at the desired Start or Stop command and press Enter.

Selecting Abort All Tests from the Test menu will not disrupt a send and monitor 511 test.

The **Results** column displays the test duration.

When the Send and Monitor 511 test is active, ResetMon is available to reset the error counter to zero.

Line Loopback

Line Loopback (LLB) loops the received signal on the network interface back to the network without change.

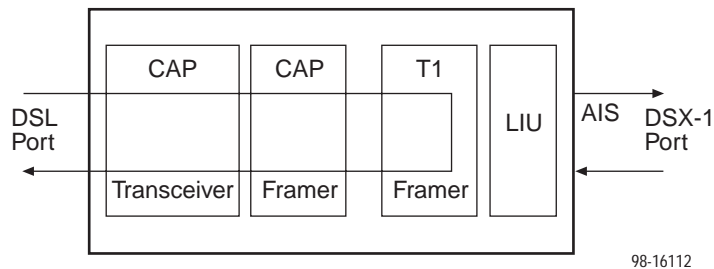

► Procedure

To run a Line Loopback:

1. Position the cursor at the Start command next to Line Loopback on the Network Tests screen.
2. Press Enter.
The Start command is changed to Stop.
3. To manually stop the test, verify that the cursor is positioned at the Stop command.
4. Press Enter.

Line Loopback cannot be started when another loopback or pattern test is in progress.

Repeater Loopback

Repeater Loopback (RLB) loops the signal being sent from the DSX-1 port back to the DSX-1 port and to the network interface.

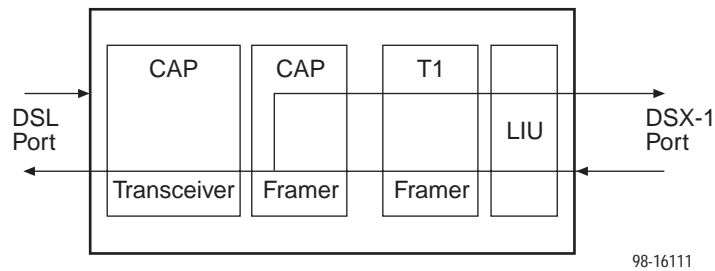

► Procedure

To run a Repeater Loopback:

1. Position the cursor at the Start command next to Repeater Loopback on the Network Tests screen.
2. Press Enter.
The Start command is changed to Stop.
3. To manually stop the test, verify that the cursor is positioned at the Stop command.
4. Press Enter.

A Repeater Loopback cannot be started when any other loopback test is in progress.

NOTE:

Activating the Repeater Loopback test causes the EOC to be lost to the remote unit.

DTE Loopback

DTE Loopback loops the DSX signal back to itself before the signal is sent to the Framer.

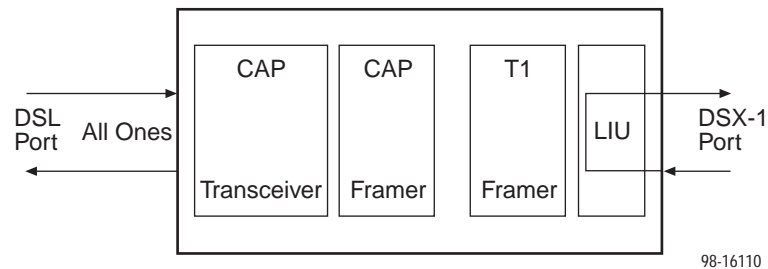

► Procedure

To run a DTE Loopback:

1. Position the cursor at the Start command next to DTE Loopback on the Network Tests screen.
2. Press Enter.
The Start command is changed to Stop.
3. To manually stop the test, verify that the cursor is positioned at the Stop command.
4. Press Enter.

A DTE Loopback cannot be started when any other loopback test is in progress.

Send Remote Line Loopback

The local unit initiates this test by sending a line loopback up or down command to the remote unit for 10 seconds. When the remote unit detects the loopback up command, it puts itself in line loopback and lights the front panel test LED. The remote unit remains in loopback until it receives a loopback down command or the remote unit's test timeout value is exceeded. The send line loopback tests both units. External equipment can be used to verify the link.

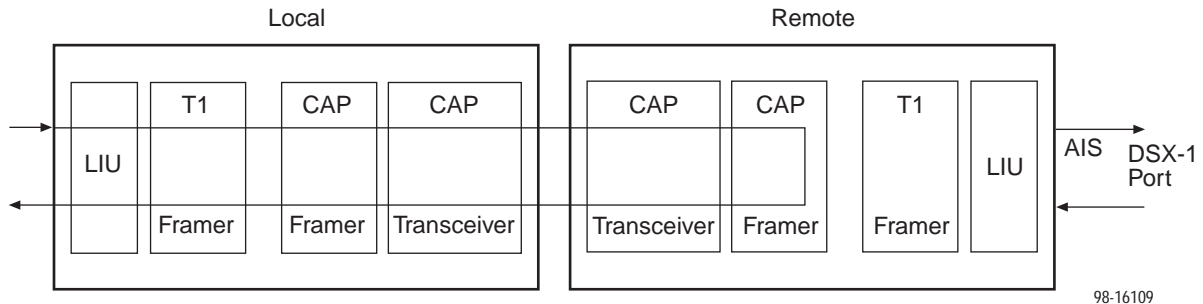

► Procedure

To run a Remote Send Line loopback:

1. Position the cursor at the Up or Down selection next to Send Line Loopback on the Network Tests screen.
2. Press the spacebar to select either Up or Down.
3. Position the cursor at the Send command next to Up or Down selection.
4. Press Enter.

The local unit stops sending the loopback command automatically after 10 seconds. You cannot stop the Send Remote Line Loopback test manually.

The Send Remote Line Loopback cannot be started when any other loopback or a Send and Monitor 511 test is active on the network interface.

Send and Monitor 511

The test is initiated by sending a command to the remote unit to send a 511 test pattern. When the remote unit detects the command, it sends a 511 pattern and lights the front panel test LED. Each unit will send and monitor the 511 pattern. The duration and results of the test are displayed on the Network Test screen to the unit that initiated the test.

NOTE:

The send and monitor test is not a loopback test. Each unit independently sends and monitors a 511 pattern.

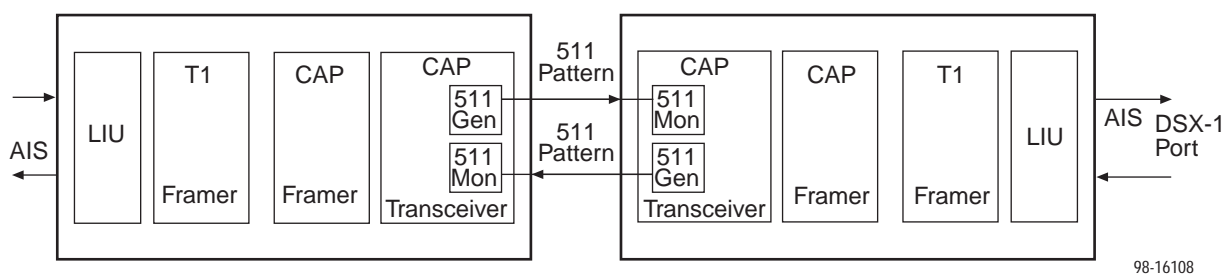

► Procedure

To run a Send and Monitor 511 test:

1. Position the cursor at the Start command next to Send and Monitor 511 on the Network Tests screen.
2. Press Enter.
The Start command is changed to Stop.
3. To manually stop the test, verify that the cursor is positioned at the Stop command.
4. Press Enter.

When a Send and Monitor 511 test is active, a count of bit errors is displayed next to the test duration, and the ResetMon virtual function key is available for use. Type r or R or select the ResetMon virtual function key to reset the error count.

Device Tests

The Device Tests branch is used to access the only card-level test, the Lamp Test. To access the Device Tests screen, follow this menu selection sequence:

Main Menu → Test → Device Tests

```
main/test/card                                     Hotwire
                                                    Model: 8784

                DEVICE TESTS

                Test      Command  Status
-----
                Lamp Test: Start   Inactive

-----

Ctrl-a to access these functions, ESC for previous menu      MainMenu  Exit
```

Lamp Test

The Lamp test determines whether all LEDs are lighting and functioning properly.

► Procedure

To test the LEDs:

1. Position the cursor at the Start command next to Lamp Test on the Card Tests screen.
2. Press Enter.
The Start command is changed to Stop. During the Lamp test, all LEDs blink simultaneously every second. When you stop the Lamp test, the LEDs are restored to their normal condition.
3. To stop the lamp test, position the cursor at the Stop command.
4. Press Enter.

Ending an Active Test

Except for the Remote Send Line Loopback and Remote DCLB, a test initiated by the user can be ended by the user. Tests can also be terminated automatically by enabling the Test Timeout option from the System Options Menu.

- A Test Timeout option is available to automatically terminate a user-initiated Loopback or Pattern test (as opposed to manually terminating a test) after it has been running a specified period of time. The default is 10 minutes. Refer to Table A-4, [System Options](#).
- On each test screen is a Command column. To stop the test, press Enter when the cursor is on the Stop command.
- Use the Abort All Tests selection from the Test menu to stop all tests running on all interfaces, with the exception of network-initiated loopbacks. **Command Complete** appears when all tests on all interfaces have been terminated.

An aborted test may continue to run for a few seconds as the abort command is sent to the remote end and processed.

Messages and Troubleshooting

6

Overview

There are many messages available to assess the status of the device and contribute to problem resolutions. Refer to the following sections:

- *Configuring SNMP Traps*
- *Device Messages*
- *Troubleshooting*

Configuring SNMP Traps

An SNMP trap can be automatically sent out through the EOC or the Management port to the SNMP manager when the 8784 Termination Unit detects conditions set by the user. These traps enable the SNMP manager to gauge the state of the network. Refer to Appendix B, *Standards Compliance for SNMP Traps*, for details of SNMP traps supported by the 8784 Termination Unit.

To configure the 8784 Termination Unit for SNMP traps, use the SNMP Traps Options screen to:

- Enable SNMP traps.
- Set the number of SNMP managers that receive SNMP traps from the 8784 Termination Unit.
- Enter an IP address and network destination for each SNMP manager specified.
- Select the type of SNMP traps to be sent from the 8784 Termination Unit.

To configure SNMP Traps, follow this menu selection sequence:

Main Menu → Configuration → Load Configuration From → Management and Communication Options → SNMP Traps Options

```

main/config/management/trap                               Hotwire
Slot: 4                                                    Model: 8784

                                SNMP TRAPS OPTIONS

SNMP Traps:           Enable           Number of Trap Managers: 5

NMS 1 IP Address: 135.014.040.001 Clear   Destination: IMC
NMS 2 IP Address: 135.014.003.027 Clear   Destination: IMC
NMS 3 IP Address: 135.014.001.008 Clear   Destination: IMC
NMS 4 IP Address: 135.014.002.024 Clear   Destination: IMC
NMS 5 IP Address: 204.128.146.035 Clear   Destination: IMC

General Traps:           Both
Enterprise Specific Traps: Enable
Link Traps:              Both
Link Traps Interfaces:   Network

-----
Ctrl-a to access these functions, ESC for previous menu   MainMenu  Exit
Save
    
```

Refer to Table A-6, *SNMP Traps Options*, to configure SNMP traps.

Device Messages

The **Device Messages** in Table 6-1, listed in alphabetical order, may appear in the messages area at the bottom of the ATI screens.

Table 6-1. Device Messages (1 of 2)

Device Message	What Message Indicates	What To Do
Access level is Operator. Configuration is read-only.	The operator requested that configuration options be loaded, but does not have authority to edit them.	If configuration options are to be edited, use a Login ID that has Administrator authority.
Cannot Save – no Login IDs with Access Administrator	All of the login IDs being saved have an access level below Administrator.	Change the access level of at least one Login ID to Administrator so that configuration changes can be made. (Operator-level users cannot make configuration changes.) Save the Login IDs.
Command Complete	Action requested has successfully completed.	No action needed.
Invalid Character (x)	A nonprintable ASCII character (x) has been entered.	Reenter information using valid characters.
Invalid Password	Login is required and an incorrect password was entered; access is denied.	<ul style="list-style-type: none"> ■ Try again. ■ Contact your system administrator to verify your password.
Invalid – Send Pattern Already Active	A pattern test was already in progress when the Start field was selected.	<ul style="list-style-type: none"> ■ Allow test to continue. ■ Select another test. ■ Stop the test.
Invalid – [Test] Already Active	The described test was already in progress when another selection was made.	<ul style="list-style-type: none"> ■ Allow test to continue. ■ Select another test. ■ Stop the test.
Invalid Test Combination	A loopback or pattern test was in progress when Start was selected to start another test, or was active on the same or another interface when Start was selected.	<ul style="list-style-type: none"> ■ Wait until other test ends and message clears. ■ Abort all tests from the Test menu screen. ■ Stop the test from the same screen the test was started from.
IP address not in MCC subnet <i>nnn.nnn.nnn.nnn</i>	The IP address specified is not in the same subnet as the MCC.	Enter an IP address that is in the same subnet as the MCC.

Table 6-1. Device Messages (2 of 2)

Device Message	What Message Indicates	What To Do
Limit of six Login IDs reached	An attempt to enter a new login ID was made, and the limit of six login/password combinations has been reached.	<ol style="list-style-type: none"> 1. Delete another login/password combination. 2. Reenter the new login ID.
No Security Records to Delete	Delete was selected from the Administer Login screen, and no security records had been defined.	<ul style="list-style-type: none"> ■ No action needed. ■ Enter a security record.
Password Matching Error – Re-enter Password	Password entered in the Re-enter Password field of the Administer Logins screen does not match what was entered in the Password field.	<ul style="list-style-type: none"> ■ Try again. ■ Contact your system administrator to verify your password.
Please Wait	Command takes longer than 5 seconds.	Wait until message clears.
Test Active	A test is running and no higher priority health and status messages exist.	<ul style="list-style-type: none"> ■ Contact service provider if test initiated by the network. ■ Wait until the other test ends and message clears. ■ Cancel all tests from the Test screen. ■ Stop the test from the same screen the test was started from.
0.0.0.0 is an invalid IP address	An IP address of all zeroes was entered.	Enter a valid, non-zero IP address.

Troubleshooting

This 8784 Termination Unit is designed to provide you with many years of trouble-free service. If a problem occurs, however, refer to Table 6-2 for possible solutions.

Table 6-2. Troubleshooting (1 of 2)

Symptom	Possible Cause	Solutions
Alarm LED is on.	A system failure has occurred.	Refer to Table 4-1, Health and Status Messages , for recommended action.
Cannot access the 8784 Termination Unit via the ATI.	The terminal is not set up for the correct rate or data format, or the 8784 Termination Unit is configured so it prevents access.	<ul style="list-style-type: none"> ■ Check the cable and connections. ■ Ensure that the 8784 Termination Unit is configured properly in the DSLAM. Verify its IP address. ■ Reset the 8784 Termination Unit.
Device Fail appears on the System and Test Status screen under Self-Test results.	The 8784 Termination Unit detects an internal hardware failure.	<ul style="list-style-type: none"> ■ Reset the 8784 Termination Unit. ■ Contact your service representative.
No power, or the LEDs are not lit.	The power cord is not securely plugged into the wall receptacle and into the rear panel connection.	Check that the power cord is securely attached at both ends.
	The wall receptacle has no power.	<ul style="list-style-type: none"> ■ Check the wall receptacle power by plugging in some equipment that is known to be working. ■ Check the circuit breaker. ■ Verify that your site is not on an energy management program.
	Power supply has failed.	Replace power supply.
An LED is not lit.	LED is out.	Run the Lamp test. If the LED in question does not flash with the other LEDs, then contact your service representative.

Table 6-2. Troubleshooting (2 of 2)

Symptom	Possible Cause	Solutions
Not receiving data.	<ul style="list-style-type: none"> ■ The network or DSX-1 port cables are not connected (check front panel LEDs for more information). ■ A test is being executed on the unit (check the TEST LED on the front panel). ■ The far-end device is offline. 	<ul style="list-style-type: none"> ■ Check network and DSX-1 port cables. ■ Check Health and Status menu. ■ Run Loopback tests. Refer to Chapter 5, <i>Testing</i>. ■ Stop the test or wait for the test to end. ■ Make sure the far-end device is on.
Power-Up Self-Test fails. Only Alarm LED is on after power-up.	The 8784 Termination Unit has detected an internal hardware failure.	<ul style="list-style-type: none"> ■ Reset the 8784 Termination Unit and try again. ■ Contact your service representative.

Security

7

Overview

The 8784 Termination Unit provides several methods of security by limiting user access to the ATI through option settings. You can:

- Enable the Telnet Login Required option.
- Limit the access by setting a Session Access Level option of Operator for the Telnet Session.
- Disable the access with the Telnet Session option.

See Table A-5, [Telnet Session Options](#), in Appendix A, *Configuration Option Tables*.

ATI Access Levels

The 8784 Termination Unit has two access levels: Administrator and Operator. The access level determines what functions are accessible, as shown in Table 7-1.

Table 7-1. Access Levels

ATI Access to Menu Functions	Administrator	Operator
Status	Read-Only	Read-Only
Test	Full Access	No Access
Configuration	Full Access	Read-Only
Control	Full Access	No Access

The effective access level is the more restrictive of the session access level or the login access level.

Access level is also used to control access via Telnet. If the Telnet Session Access Level is set to Administrator (see Table A-5, [Telnet Session Options](#)), a Login ID with an Operator access level is not permitted access.

Creating a Login

Logins apply to Telnet access directly to the ATI of the 8784 Termination Unit. The Administer Logins menu option is not presented when you access the unit through the MCC.

Six login ID/password combinations are available. Each Login ID and Password must be unique and include an access level.

► Procedure

1. To create a login record, follow this menu selection sequence:

Main Menu → Control → Administer Logins

```
main/control/admin_logins                               Hotwire
Slot: 4                                                 Model: 8784

                                     ADMINISTER LOGINS           Page 1 of 1

Login ID:                newuser
Access Level:            Administrator

                                     Are You Sure? Yes

-----
Save  PgUp  PgDn                ESC for previous menu      MainMenu  Exit
                                     New                    Delete
```

2. Select New and press Enter. The Login Entry screen is displayed.

```

main/control/admin_logins                               Hotwire
Slot: 4                                                Model: 8784

                LOGIN ENTRY

Login ID:          newuser
Password:          e34t136
Re-enter Password: e34t136
Access Level:      Administrator

                WARNING
New logins will not become permanent until saved
through the "ADMINISTER LOGINS" screen!

-----
Ctrl-a to access these functions  ESC for previous menu      MainMenu  Exit
Save  PgUp  PgDn                                     New      Delete

```

3. Create the login by entering the following fields. Login IDs and passwords are case-sensitive.

On the Login Entry screen, for the ...	Enter ...
Login ID	1 to 10 ASCII printable characters (hex21 through 7E). Blanks are not allowed.
Password	1 to 10 ASCII printable characters that can consist of 0-9, a-z, A-Z, # (pound), . (period), - (dash), and / (slash).
Re-enter Password	1 to 10 ASCII printable characters characters that can consist of 0-9, a-z, A-Z, # (pound), . (period), - (dash), and / (slash).
Access Level	Administrator, Operator

NOTE:

Assign at least one Administrator-level Login ID. Full access is necessary to make configuration option changes and administer logins.

4. Press Ctrl-a to switch to the screen function key area below the dotted line. Select Save and press Enter.
5. When Save is complete, **Command Complete** appears at the bottom of the screen.
6. If additional logins are required, repeat Steps 3 through 5.
7. When all logins are entered, press Esc to return to the Administer Logins screen.
8. Select Save and press Enter.

Deleting a Login

► Procedure

1. To delete a login record, follow this menu selection sequence:

Main Menu → Control → Administer Logins

2. Select PgUp or PgDn and press Enter to page through login pages/records until you find the one to be deleted.
3. Once the correct record is displayed, select De|lete and press Enter.
4. To complete the delete action, select S|ave and press Enter.

When the deletion is complete, **Command Complete** appears at the bottom of the screen. The number of login pages/records reflects one less record, and the record following the deleted record appears.

Controlling SNMP Access

There are three methods for limiting SNMP access.

- Disable the SNMP management option. Refer to Table A-7, **General SNMP Management Options**.
- Assign SNMP community names and access types.
- Limit SNMP access through validation of the IP address of each allowed SNMP manager.

Assigning SNMP Community Names and Access Types

The unit can be managed by an SNMP manager supporting SNMP. The community name must be supplied by an external SNMP manager accessing an object in the MIB.

To define SNMP community names, follow this menu selection sequence:

*Main Menu → Configuration → Load Configuration From → Edit →
SNMP → General SNMP Management*

Refer to Table A-7, **General SNMP Management Options**, to:

- Enable SNMP Management.
- Assign the SNMP community names of the SNMP Managers that are allowed to access the units Management Information Base (MIB).
- Specify Read or Read/Write access for each SNMP community name.

Limiting SNMP Access through the IP Addresses of the Managers

The unit provides an additional level of security through validation of the IP addresses.

The SNMP Management option must be enabled. To control SNMP access with IP addresses, follow this menu selection sequence:

Main Menu → Configuration → Management → Security Menu

Refer to Table A-8, **SNMP NMS Security Options**. The SNMP access can be limited by:

- Enabling NMS IP address checking.
- Add each IP address and access level.

NOTE:

Do not change or delete the IP address or access level of the NMS performing the sets or enable IP address checking prior to adding the NMS to the table.

IP Addressing

8

Selecting an IP Addressing Scheme

The NTU's network interface IP address is assigned through the peer IP address of the LTU's Network Interface menu. The NTU obtains the LTU's IP address and subnet mask when the PPP link is established over the EOC. The LTU IP address and subnet mask are configured from the Communication Protocol Options menu.

The 8784 Termination Unit is assigned an IP address and subnet through the DSLAM DSL Card Configuration menu. Once the address is assigned, you can use the 8784 Termination Unit's ATI to assign:

- Peer IP addresses to the four M/HDSL ports. These addresses are used as the IP addresses of the remote units. See Table A-1, *Network Interface Options*, in Appendix A, *Configuration Option Tables*.
- An IP address for each NMS to act as a trap manager. See Table A-6, *SNMP Traps Options*, in Appendix A, *Configuration Option Tables*.
- An IP address for the TFTP server you wish to use to upload and download configurations. See *Configuration Loader* in Chapter 3, *Initial Startup and Configuration*.

Review the following information in preparation for selecting an IP addressing scheme.

- Any legal host address is allowed for a given subnet. The address choice within the subnet is arbitrary.
- A single route to a subnet is all that is needed to reach every device on a subnet. The 8784 Termination Unit's routing table supports a maximum of 20 routes.

IP Addressing Example

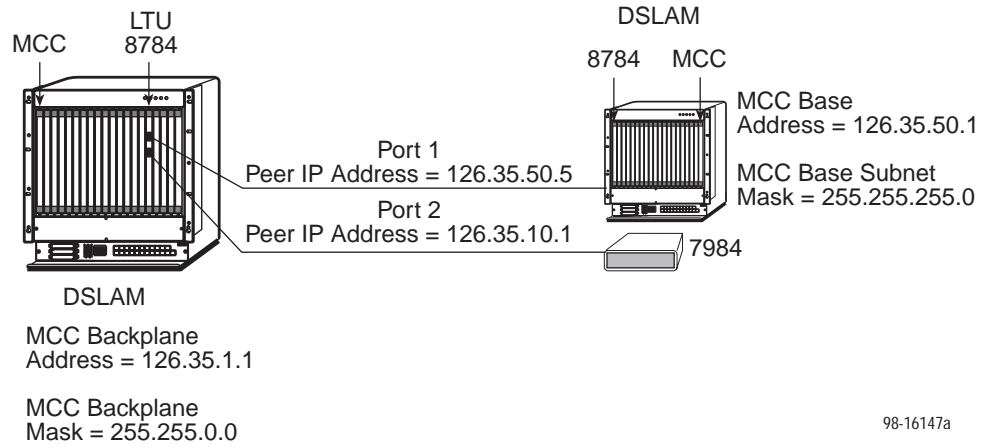

Peer IP Address Assignments

- The Peer IP Address refers to the IP address of the unit configured as an NTU.
- The Peer IP Address is assigned by the LTU.

Configuration Option Tables



Overview

The tables in this appendix summarize the configuration options accessed when you select Configuration on the Main Menu. The configuration options are arranged into groups based upon functionality.

Select . . .	To Access the . . .	To Configure the . . .
Network	Network Interface Options , Table A-1	T1 HDSL network interface Ports 1–4.
DSX Interface	DSX-1 Interface Options , Table A-2	DSX interface port.
Copy Ports	Copy Ports Options , Table A-3	T1 HDSL network and DSX-1 interface ports by copying options from port to port.
System	System Options , Table A-4	General system options of the unit.
Management and Communication	<ul style="list-style-type: none">■ Telnet Session Options, Table A-5■ SNMP Traps Options, Table A-6■ General SNMP Management Options, Table A-7■ SNMP NMS Security Options, Table A-8	Management support of the unit through SNMP and Telnet.

NOTE:

All changes to configuration options must be saved. Refer to [Saving Configuration Options](#) in Chapter 3, *Initial Startup and Configuration*.

Network Interface Options Menu

For Network Interface Options, refer to Table A-1. To access the Network Interface Options screen, follow this menu selection sequence:

Main Menu → *Configuration* → *Current Configuration* → *Network*

```

main/config/network
Slot 4
Port 2
Hotwire
Model: 8784

NETWORK INTERFACE OPTIONS

Margin Threshold:          -3db
Excessive Error Rate Threshold: 1E-6

Peer IP Address:          111.255.255.000 Clear
Circuit Identifier: _____ Clear

-----
Ctrl-a to access these functions, ESC for previous menu   MainMenu Exit
Save
    
```

Table A-1. Network Interface Options (1 of 2)

Margin Threshold
Possible Settings: -5db, -4db, -3db, -2db, -1db, 0db, 1db, 2db, 3db, 4db, 5db, 6db, 7db, 8db, 9db, 10db Default Setting: 0db
Determines the level, expressed in decibels, at which a signal-to-noise margin condition is recognized. -5db to 10db – Sets the margin threshold to this value.
Excessive Error Rate Threshold
Possible Settings: 1E-4, 1E-5, 1E-6, 1E-7, 1E-8, 1E-9 Default Setting: 1E-6
Determines the error rate at which an excessive error rate (EER) condition is recognized. The rate is the ratio of the number of CRC errors to the number of bits received in a certain period.

Table A-1. Network Interface Options (2 of 2)

Peer IP Address (LTU Only)
Possible Settings: 000.000.000.001 – 223.255.255.255, Clear Default Setting: 000.000.000.001
Specifies the peer IP address providing the remote management link on the DSL loop. The Peer IP Address is only available when the unit is configured as an LTU. Address Field – (000.000.000.001 – 223.255.255.255) – Enter an address for the peer unit. The range for the first byte is 000 to 223, with the exception of 127. The range for the remaining three bytes is 000 to 255. The IP address must be in the same subnet as the MCC backplane address. Clear – Clears the IP address and sets to all zeros.
Circuit Identifier
Possible Settings: [ASCII Text], Clear Default Setting: [blank]
Uniquely identifies the circuit number of the transmission vendor's DSL line for troubleshooting purposes. [ASCII Text] – Enter a maximum of 128 characters. All printable ASCII characters except ^ (caret) are allowed. Clear – Clears the field.

DSX-1 Interface Options

For DSX-1 Interface Options, refer to Table A-2. To access the DSX-1 Interface Options screen, follow this menu selection sequence:

Main Menu → Configuration → Load Configuration From → DSX-1

```

main/config/DSX-1
Slot 4
Port 2
Hotwire
Model: 8784

DSX-1 INTERFACE OPTIONS

Port Status:          Enable
Line Framing:         ESF
Line Coding:           B8BS
Line Equalization:    0 -133
Excessive Error Rate Threshold: 1E-4
Send (AIS) on Network Failure: Enable
Send All Ones on DSX-1 Failure: Enable
Primary Clock Source: DSX-1

-----
Ctrl-a to access these functions, ESC for previous menu   MainMenu   Exit
Save
    
```

Table A-2. DSX-1 Interface Options (1 of 2)

Port Status
Possible Settings: Enable, Disable Default Setting: Enable
Determines whether the port can be configured and used. Enable – The port can be configured and used. Disable – The port cannot be configured or used. Configuration fields for the port are inaccessible, no alarms or traps associated with the port are generated, and the LED associated with the port is OFF.
Line Framing (LTU Only)
Possible Settings: ESF, D4 Default Setting: ESF
Specifies the framing format to be used by the DSX interface. <ul style="list-style-type: none"> ■ Line Framing is only available when the standalone unit is configured as an LTU. The NTU is automatically configured to match the framing format used by the LTU. ESF – ESF framing formatting is used for transmitted and received data over the DSX-1 Interface. D4 – D4 framing format is used for transmitted and received data over the DSX-1 Interface.

Table A-2. DSX-1 Interface Options (2 of 2)

Line Coding Format
Possible Settings: AMI, B8ZS Default Setting: B8ZS
Specifies the line coding format to be used by the DSX interface. AMI – Indicates the line coding format used by the DSX interface is Alternate Mark Inversion (AMI). B8ZS – Indicates the line coding format used by the DSX interface is B8ZS.
Line Equalization
Possible Settings: 0-133, 133-266, 266-399, 399-533, 533-655 Default Setting: 0-133
Compensates for signal distortion for a DSX-1 signal over a given distance. 0–133 feet – Provides equalization for a cable length up to 133 feet. 133–266 feet – Provides equalization for a cable length up to 266 feet. 266–399 feet – Provides equalization for a cable length up to 399 feet. 399–533 feet – Provides equalization for a cable length up to 533 feet. 533–655 feet – Provides equalization for a cable length up to 655 feet.
Send AIS on Network Failure
Possible Settings: Enable, Disable Default Setting: Enable
Specifies the action taken on the signal transmitted to the DSX-1 when a valid signal cannot be recovered from the network interface (LOS or OOF). Enable – An Alarm Indication Signal (AIS) is sent to the DSX-1 port in the event of an LOS or OOF condition on the network interface. Disable – The failed signal on the interface is passed through to the DSX-1 network unchanged.
Send All Ones on DSX-1 Failure
Possible Settings: Enable, Disable Default Setting: Enable
Specifies the action taken on the signal transmitted to the network when a valid signal cannot be recovered from the network interface (LOS or OOF). Enable – A pattern of all ones is sent to the DSX-1 port in the event of an LOS or LOF condition on the DSX-1 interface. Disable – The failed signal on the interface is passed through to the DSX-1 network unchanged.
Primary Clock Source
Possible Settings: DSX-1, Internal Default Setting: Internal
Specifies where the unit will derive its timing from. Internal – The clock source is derived from the internal oscillator. DSX-1 – The clock source is derived from the DSX-1 interface.

Copy Ports Options

You can copy the configuration options of DSX-1 interface and DSL loop to another using the Copy Ports screen. For Copy Ports options, refer to Table A-3. To access the Copy Ports screen, follow this menu selection sequence:

Main Menu → Configuration → Load Configuration From → Copy Ports

```

main/config/copy                               Hotwire
slot 4                                         Model: 8784

                                         COPY PORTS

                                         From: Port n:
                                         To:  Port y:

Perform Copy

Perform Copy Then Increment

-----
Save                                         ESC for previous menu      MainMenuExit
    
```

Table A-3. Copy Ports Options

From: Port <i>n</i>
Possible Settings: 1, 2, 3, 4 Default Setting: 1
Controls the source of the configuration options. 1 to 4 – The configuration of the selected port is copied.
To: Port <i>y</i>
Possible Settings: 1, 2, 3, 4, All Default Setting: 2
Controls the target of the configuration options. 1 to 4 – The configuration of the selected port is replaced. If Perform Copy Then Increment is selected, the port number is incremented by 1 after the copy. All – The configurations of all ports are replaced by the configuration of the selected From: Port.
NOTE: Peer IP Address and Circuit Identifier are <i>not</i> copied.

System Options

For System Options, refer to Table A-4. To access the System Options screen, follow this menu selection sequence:

Main Menu → Configuration → Load Configuration From → System

```

main/config/system                               Hotwire
Slot 4                                           Model: 8784

                                SYSTEM OPTIONS

                                DSL Mode:          LTU
                                Test Timeout:       Enable
                                Test Duration (min): 10
                                Telco Initiated Loopbacks: Enable
                                Remote Telco Line Loopback: Disabled

-----
Ctrl-a to access these functions, ESC for previous menu      MainMenu  Exit
Save
    
```

Table A-4. System Options (1 of 2)

DSL Mode
Possible Settings: LTU, NTU Default Setting: LTU
Controls whether the unit is configured as a control unit or tributary unit. LTU – The unit is configured as a control unit (Line Termination Unit). NTU – The unit is configured as a tributary unit (Network Termination Unit). This unit will request its IP address from the LTU during establishment of the PPP link. NOTE: Changing this option will reset the card.
Test Timeout
Possible Settings: Enable, Disable Default Setting: Enable
Allows tests to end automatically. The feature should be enabled when the unit is remotely managed, so that control can be regained after a test is accidentally executed. Enable – Loopback and pattern tests end when test duration is reached. Disable – Tests run until manually terminated from the Network Tests screen or remotely (network initiated tests). Refer to <i>Running Network Tests</i> in Chapter 5, <i>Testing</i> .
Test Duration (min)
Possible Settings: 1–120 Default Setting: 10
Number of minutes for a test to be active before automatically ending. <ul style="list-style-type: none"> ■ Test Duration (min) option appears when Test Timeout is enabled. 1 to 120 – Amount of time in minutes for a test to run before terminating.

Table A-4. System Options (2 of 2)

Telco Initiated Loopback
Possible Settings: Enable, Disable Default Setting: Enable
Determines if the unit will respond to inband or bit oriented protocol loopback commands on the DSX-1 interface. Enable – The unit will respond to inband loopback commands. Disable – The unit will not respond to inband or bit oriented protocol loopback commands.
Remote Telco Loopback
Possible Settings: Enable, Disable Default Setting: Disable
Determines if the unit will perform a Telco initiated loopback on just the local unit or if the loopback will be performed on the remote DSL unit. Enable – The loopback will be in the remote unit. Disable – The loopback will be local.

Management and Communication Options Menu

The Management and Communication Menu allows you to access the following:

- **Telnet Session Options**, Table A-5
- **SNMP Traps Options**, Table A-6
- **General SNMP Management Options**, Table A-7
- **SNMP NMS Security Options**, Table A-8

Telnet Session Options

The Telnet session configuration options control whether a Telnet session is allowed through an interconnected IP Network. If allowed, these options determine what level of security to apply to the session to control access. Only one Telnet session is allowed at a time. Initial values are determined by the configuration you currently have loaded. To access the Telnet Sessions Options screen, follow this menu selection sequence:

Main Menu → Configuration → Load Configuration From → Management and Communication → Telnet Session

```

main/config/management/telnet                               Hotwire
Slot 4                                                       Model: 8784

                                TELNET SESSION OPTIONS

Telnet Session:                                             Enable
Telnet Login Required:                                     Enable
Session Access Level:                                     Administrator
Inactivity Timeout:                                       Enable
Disconnect Time (Minutes)                                5

-----
Ctrl-a to access these functions, ESC for previous menu    MainMenu Exit
Save
    
```

Table A-5. Telnet Session Options

Telnet Session
Possible Settings: Enable, Disable Default Setting: Enable
Specifies if the 8784 Termination Unit will respond to a Telnet session request from a Telnet client on an interconnected IP network.
Enable – Allows Telnet sessions between the unit and a Telnet client.
Disable – No Telnet sessions allowed.

Table A-5. Telnet Session Options

Telnet Login Required
Possible Settings: Enable, Disable Default Setting: Disable
Specifies whether a user ID and password are required to access to the ATI through a Telnet session. Login IDs are created with a password and access level. Refer to <i>Creating a Login</i> in Chapter 7, <i>Security</i> . Enable – Security is enabled. When access is attempted via Telnet, the user is prompted for a Login ID and password. Disable – No Login required for a Telnet session.
Session Access Level
Possible Settings: Administrator, Operator Default Setting: Administrator
The Telnet session access level is interrelated with the access level of the Login ID. Refer to <i>ATI Access Levels</i> in Chapter 7, <i>Security</i> , for more information. Administrator – This is the higher access level, permitting full control of the 8784 Termination Unit. Access level is determined by the Login ID. If Telnet Login Required is disabled, the session access level is Administrator. Operator – This is the lower access level, permitting read-only access to status and configuration screens.
Inactivity Timeout
Possible Settings: Enable, Disable Default Setting: Disable
Provides automatic logoff of a Telnet session. Enable – The Telnet session terminates automatically after the Disconnect Time. Disable – A Telnet session will not be closed due to inactivity.
Disconnect Time (Minutes)
Possible Settings: 1–60 Default Setting: 5
Number of minutes of inactivity before a Telnet session terminates automatically. Timeout is based on no keyboard activity. <ul style="list-style-type: none"> ■ Disconnect Time (minutes) option appears when Inactivity Timeout is enabled. 1 to 60 – The Telnet session is closed after the selected number of minutes.

SNMP Traps Options

SNMP configuration options allow you to specify the information necessary to support the 8784 Termination Unit SNMP traps. To access the SNMP Traps Options screen, follow this menu selection sequence:

Main Menu → Configuration → Load Configuration From → Edit → Management and Communication → SNMP Traps

```

main/config/management/trap                               Hotwire
Slot: 4                                                    Model: 8784

                                SNMP TRAPS OPTIONS

SNMP Traps:           Enable           Number of Trap Managers: 5

NMS 1 IP Address: 135.014.040.001 Clear
NMS 2 IP Address: 135.014.003.027 Clear
NMS 3 IP Address: 135.014.001.008 Clear
NMS 4 IP Address: 135.014.002.024 Clear
NMS 5 IP Address: 204.128.146.035 Clear

General Traps:           Both
Enterprise Specific Traps: Disable
Link Traps:             Both
Link Traps Interfaces:  All

-----
Ctrl-a to access these functions, ESC for previous menu      MainMenu  Exit
Save

```

Table A-6. SNMP Traps Options (1 of 3)

SNMP Traps
Possible Settings: Enable, Disable Default Setting: Disable
Controls the generation of SNMP trap messages. The options for addresses and types of traps are located in this table. Enable – SNMP trap messages are sent out to SNMP managers. Disable – No SNMP trap messages are sent out.
Number of Trap Managers
Possible Settings: 1, 2, 3, 4, 5 Default Setting: 1
Sets the number of SNMP management systems that will receive SNMP traps. 1 to 5 – Number of trap managers. An NMS IP address is required for each manager.

Table A-6. SNMP Traps Options (2 of 3)

NMS <i>n</i> IP Address
Possible Settings: 000.000.000.000 – 223.255.255.255, Clear Default Setting: 000.000.000.000
Specifies the Internet Protocol address used to identify each SNMP trap manager. 000.000.000.000 – 223.255.255.255 – Enter an address for each SNMP trap manager. The range for the first byte is 000 to 223, with the exception of 127. The range for the remaining three bytes is 000 to 255. Clear – Clears the IP address and sets to all zeros.
NMS <i>n</i> Destination (NTU Only)
Possible Settings: IMC, DSL1, DSL2, DSL3, DSL4 Default Setting: IMC
Provides the network destination path of each trap manager. IMC – The Internal Management Channel (IMC) is the default network destination. This is the management interface to the MCC card in the DSLAM. DSL1 to DSL4 – The specified port is the network destination.
General Traps
Possible Settings: Disable, Warm, AuthFail, Both Default Setting: Both
Determines which SNMP traps are sent to each trap manager. Disable – No general trap messages are sent. Warm – Sends trap message for <i>warmStart</i> events. AuthFail – Sends trap message for <i>authenticationFailure</i> events. Both – Sends both trap messages. NOTE: Refer to Appendix B, <i>Standards Compliance for SNMP Traps</i> .
Enterprise Specific Traps
Possible Settings: Enable, Disable Default Setting: Disable
Determines if SNMP traps are generated for enterprise-specific events. Enable – SNMP traps are generated for <i>enterpriseSpecific</i> events. NOTE: Refer to <i>Enterprise Specific Traps</i> in Appendix B, <i>Standards Compliance for SNMP Traps</i> . Disable – No enterprise-specific event traps are sent.

Table A-6. SNMP Traps Options (3 of 3)

Link Traps
Possible Settings: Disable, Up, Down, Both Default Setting: Both
Determines if SNMP traps are generated for link up and link down for one of the communication interfaces. Disable – No <i>linkUp</i> or <i>linkDown</i> SNMP traps are generated. Up – A <i>linkUp</i> trap is generated when the 8784 Termination Unit recognizes that one of the communication interfaces is operational. Down – A <i>linkDown</i> trap is generated when the 8784 Termination Unit recognizes a failure in one of the communication interfaces. Both – Sends trap messages for detection of both <i>linkUp</i> and <i>linkDown</i> . NOTE: Refer to <i>linkUp and linkDown</i> in Appendix B, <i>Standards Compliance for SNMP Traps</i> .
Link Trap Interfaces
Possible Settings: Network, DSX-1, All Default Setting: All
Determines if the SNMP <i>linkUp</i> , SNMP <i>linkDown</i> , and interface-related <i>enterpriseSpecific</i> traps are generated for the network DSL interface and/or DSX-1 interface (DTE). Network – SNMP trap messages are generated for the DSL network interface. DSX-1 – SNMP trap messages are generated for the DSX-1 interface. All – SNMP trap messages are generated for the DSL network interface and the DSX-1 interface.

General SNMP Management Options

SNMP configuration options allow you to specify the information necessary to support the 8784 Termination Unit General SNMP functionality. To access the General SNMP Management Options screen, follow this menu selection sequence:

Main Menu → Configuration → Load Configuration From → Edit → Management and Communication → SNMP

```

main/config/management/SNMP                               Hotwire
Slot: 4                                                    Model: 8784

                                GENERAL SNMP MANAGEMENT OPTIONS

SNMP Management:      Enable

Community Name 1:    Public
Name 1 Access:      Read/Write
Community Name 2:    Public
Name 2 Access:      Read/Write

-----
Ctrl-a to access these functions, ESC for previous menu      MainMenu  Exit
Save
    
```

Table A-7. General SNMP Management Options (1 of 2)

SNMP Management
Possible Settings: Enable, Disable Default Setting: Disable
Enable or disables the SNMP management features. Enable – Enables SNMP management capabilities. Disable – Disables SNMP management capabilities.
Community Name 1
Possible Settings: ASCII text field, Public Default Text: Public
Identifies the name of the community allowed to access the unit's MIB. The community name must be supplied by an external SNMP manager when that manager attempts to access an object in the MIB. Text Field – Enter or edit a community name. Clear – Clears the community name field.

Table A-7. General SNMP Management Options (2 of 2)

Name 1 Access
Possible Settings: Read, Read/Write Default Setting: Read
Determines the access level for Community Name 1. Read – Allows read-only access (get) for Community Name 1. Read/Write – Allows read/write access (get) for Community Name 1.
Community Name 2
Possible Settings: ASCII text field, Public Default Text: Public
Identifies the name of the second community allowed to access the unit's MIB. The community name must be supplied by an external SNMP manager when that manager attempts to access an object in the MIB. Text Field – Enter or edit a community name. Clear – Clears the community name field.
Name 2 Access
Possible Settings: Read, Read/Write Default Setting: Read
Determines the access level for Community Name 2. Read – Allows read-only access (get) for Community Name 2. Read/Write – Allows read/write access (get/set) for Community Name 2.

SNMP NMS Security Options

SNMP configuration options allow you to specify the information necessary to support the 8774 Termination Unit SNMP NMS Security. To access the SNMP NMS Security Options screen, follow this menu selection sequence:

Main Menu → Configuration → Load Configuration From → Edit → Management and Communication → Security

```

main/config/management/security                               Hotwire
Slot: 4                                                       Model: 8784

                               SNMP NMS SECURITY OPTIONS

                               NMS IP Validation:  Enable
                               Number of Managers:  2

NMS 1 IP Address: 135.014.040.001 Clear      Access Type: Read/Write
NMS 2 IP Address: 135.014.003.027 Clear      Access Type: Read/Write
NMS 3 IP Address: 135.014.001.008 Clear      Access Type: Read
NMS 4 IP Address: 135.014.002.024 Clear      Access Type: Read
NMS 5 IP Address: 204.128.146.035 Clear      Access Type: Read

-----
Ctrl-a to access these functions, ESC for previous menu      MainMenu  Exit
Save
    
```

Table A-8. SNMP NMS Security Options (1 of 2)

NMS IP Validation
Possible Settings: Enable, Disable Default Setting: Disable
Specifies whether security checking is performed on the IP address of SNMP management systems attempting to access the node. Enable – Security checking is performed on the IP address of SNMP management systems attempting to access the node. Disable – No security checking is performed.
Number of Managers
Possible Settings: 1, 2, 3, 4, 5 Default Setting: 1
Specifies the number of SNMP management systems that can send SNMP messages. 1 to 5 – Number of trap managers. An NMS IP address is required for each manager.

Table A-8. SNMP NMS Security Options (2 of 2)

NMS <i>n</i> IP Address
Possible Settings: 000.000.000.000 – 223.255.255.255, Clear Default Setting: 000.000.000.000
Specifies the Internet Protocol address used to identify each SNMP manager. 000.000.000.000 – 223.255.255.255 – Enter an address for each SNMP manager. The range for the first byte is 000 to 223, with the exception of 127. The range for the remaining three bytes is 000 to 255. Clear – Clears the IP address and sets to all zeros.
Access Level
Possible Settings: Read, Read/Write Default Setting: Read
Determines the access level allowed for an authorized NMS when IP address validation is being performed. Read – Allows read-only access (get) to the accessible objects in the MIB for this device. Read/Write – Allows read/write access (get/set) to the accessible objects in the MIB for this device.

Standards Compliance for SNMP Traps

B

SNMP Traps

This section describes the unit's compliance with SNMP standards and any special operational features for the SNMP traps supported. The unit supports the following traps:

- warmStart
- authenticationFailure
- linkUp
- linkDown

warmStart

SNMP Trap	Description	Possible Cause
warmStart	The unit has reinitialized itself. The trap is sent after the unit resets and stabilizes. There are no variable-bindings.	<ul style="list-style-type: none">■ Reset command.■ Power disruption.

authenticationFailure

SNMP Trap	Description	Possible Cause
authenticationFailure	Failed attempts to access the unit. There are no variable-bindings.	Three unsuccessful attempts were made to enter a correct login/password combination.

linkUp and linkDown

The link SNMP traps are:

- **linkUp** – The unit recognizes that one of the communication interfaces is operational.
- **linkDown** – The unit recognizes that one of the communication interfaces is not operational.

The network and synchronous port interfaces (physical sublayer) are represented by an entry in the MIB-II interfaces table and supported by the DS1 MIB.

The following list describes the conditions that define linkUp and linkDown:

linkUp/Down Variable-Bindings

- **ifIndex (RFC 1573)**

This object provides the index into the ifTable and potentially into tables in other MIBs. The values of ifIndex are the same for all models, although not all indexes are supported for each model.

The ifIndex included with the trap consists of the slot number times 1000, plus:

 - 2 HDSL Network Interface, Port 1
 - 3 HDSL Network Interface, Port 2
 - 10 DSX-1 Port, Port 1
 - 11 DSX-1 Port, Port 2
- **ifAdminStatus (RFC 1573)**

This object specifies the operational state of the interface:

 - up(1)
HDSL Network: DSL link is established.
Synchronous Data Port: Port is enabled and both CTS and DSR are ON.
 - down(2)
HDSL Network: DSL link is not established.
Synchronous Data Port: Port is disabled or CTS or DSR is OFF.
 - testing(3)
A test is active on the interface.
- **ifOperStatus (RFC 1573)**

This object contains the same value as ifAdminStatus.
- **ifType (RFC 1573)**

This object is the type of interface:

 - propPointToPointSerial(22)
Used for the synchronous data ports and EOC.
 - DS1 (18)
Used for DSX-1 T1 interface
 - HDSL(96)
Used for the HDSL network interface.

Enterprise-Specific Traps

The enterpriseSpecific trap indicates that an enterprise-specific event has occurred. The Specific-trap field identifies the particular trap that occurred. The following table lists the enterprise-specific traps supported by the unit:

SNMP Trap	Description	Possible Cause
enterpriseSelfTestFail(2)	A hardware failure of the unit is detected during the unit's self-test. The trap is generated after the unit completes initialization.	Failure of one or more of the unit's hardware components.
enterpriseDeviceFail(3)	An internal device failure.	Operating software has detected an internal device failure.
enterpriseTestStart(5)	A test is running.	At least one test has been started on an interface.
enterpriseConfigChange(6)	The configuration changed via the user interface. The trap is sent after 60 seconds have elapsed without another change. This suppresses the sending of numerous traps when multiple changes are made in a short period of time, as is typically the case when changing configuration options.	Configuration has been changed via the ATI.
enterpriseTestStop(105)	All tests have been halted.	All tests have been halted on an interface.

There are no variable-bindings for enterpriseDeviceFail and enterpriseConfigChange. The variable-binding for enterpriseSelfTestFail is devSelfTestResults.

The tests that affect the enterpriseTestStart, enterpriseTestStop, and the variable-bindings are different for each particular interface. Diagnostic tests are only supported on the physical T1 network and user data port interfaces. The specific tests and variable-bindings are described in the following table:

Interface	enterpriseTestStart/Stop Variable-Bindings	Possible Cause
HDSL Network	<ul style="list-style-type: none"> ■ ifIndex (RFC 1573) ■ ifAdminStatus (RFC 1573) ■ ifOperStatus (RFC 1573) ■ ifType (RFC 1573) ■ ifTestType (RFC 1573) <p>The following objects control tests in SNMP-managed devices:</p> <ul style="list-style-type: none"> – noTest – Stops the test in progress. – testLoopLLB – Initiates a Local Loopback. – testLoopRLB – Initiates a Remote Loopback. – testSendMon511 – Initiates a Send and Monitor 511 test. – testSendLLBUp – Initiates an LLB Up message to the remote unit. – testSendLLBDown – Initiates an LLB Down message to the remote unit. 	<ul style="list-style-type: none"> ■ enterpriseTest Start – Any one of the following tests is active on the interface: <ul style="list-style-type: none"> – Line Loopback – Repeater Loopback – Remote Line Loopback – Send and Monitor 511 ■ enterpriseTest Stop – No tests currently running on the interface.
DSX-1	<ul style="list-style-type: none"> ■ ifIndex (RFC 1573) ■ ifAdminStatus (RFC 1573) ■ ifOperStatus (RFC 1573) ■ ifTestType (RFC 1573) <p>The following objects control tests in SNMP-managed devices:</p> <ul style="list-style-type: none"> – noTest – Stops the test in progress. – testLoopExternalDTE 	<ul style="list-style-type: none"> ■ enterpriseTest Start – Any one of the following tests is active on the interface: <ul style="list-style-type: none"> – Data Terminal Loopback – Repeater Loopback – testLoop RLB – initiates a Repeater Loopback – testLoop DTLB – initiates a DSX-1 DTE Loopback ■ enterpriseTest Stop – No tests currently running on the interface.

Cables and Pin Assignments

C

Overview

The following sections provide connector pin assignments for the:

- *Hotwire 8600 DSLAM Telco 50-pin Connector Pinouts for DSL Loops*
- *Hotwire 8800 DSLAM Telco 50-pin Connector Pinouts for DSL Loops*
- *Hotwire 8784 Front Panel 50-pin Connector Pinouts*

Hotwire 8600 DSLAM Telco 50-pin Connector Pinouts for DSL Loops

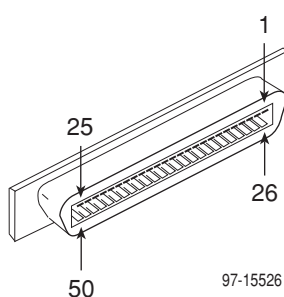

The Telco 50-pin LINE receptacle on the front panel of the 8600 DSLAM provides the 2-wire loop interface from each M/HDSL port to the MDF. The following table lists the pin assignments for each of these interfaces.

NOTE:

When the 8600 chassis is the base chassis, the MCC is installed in Slot 1 and the Tip and Ring wiring for Slot 1 is not active.

Also, Pins 13 through 25 and 38 through 50 of all Hotwire 8600 chassis are not used.

CONNECTOR (DSL Slot, Port Number)	CONNECTOR PINS (Tip, Ring)
Slot 1, Port 1 (TX)	1, 26
Slot 1, Port 1 (RX)	2, 27
Slot 1, Port 2 (TX)	3, 28
Slot 1, Port 2 (RX)	4, 29
Slot 2, Port 1 (TX)	5, 30
Slot 2, Port 1 (RX)	6, 31
Slot 2, Port 2 (TX)	7, 32
Slot 2, Port 2 (RX)	8, 33
Slot 3, Port 1 (TX)	9, 34
Slot 3, Port 1 (RX)	10, 35
Slot 3, Port 2 (TX)	11, 36
Slot 3, Port 2 (RX)	12, 37

Hotwire 8800 DSLAM Telco 50-pin Connector Pinouts for DSL Loops

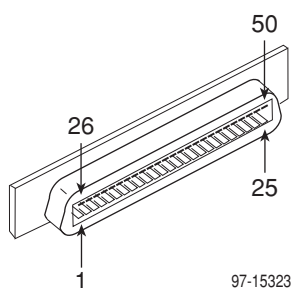

The three Telco 50-pin LINES connectors on the 8800 DSLAM Interface Module provide the 4-wire loop interface from each DSL port to the MDF. The following table lists the pin assignments for each of these interfaces. Note that Pins 25 and 50 are *not* used.

CONNECTOR 1 Slots 1–6 8784 Port Number	CONNECTOR 2 Slots 7–12 8784 Port Number	CONNECTOR 3 Slots 13–18 8784 Port Number	CONNECT. PINS (Tip, Ring)
Card 1, Port 1 (TX)	Card 7, Port 1 (TX)	Card 13, Port 1 (TX)	1, 26
Card 1, Port 1 (RX)	Card 7, Port 1 (RX)	Card 13, Port 1 (RX)	2, 27
Card 1, Port 2 (TX)	Card 7, Port 2 (TX)	Card 13, Port 2 (TX)	3, 28
Card 1, Port 2 (RX)	Card 7, Port 2 (RX)	Card 13, Port 2 (RX)	4, 29
Card 2, Port 1 (TX)	Card 8, Port 1 (TX)	Card 14, Port 1 (TX)	5, 30
Card 2, Port 1 (RX)	Card 8, Port 1 (RX)	Card 14, Port 1 (RX)	6, 31
Card 2, Port 2 (TX)	Card 8, Port 2 (TX)	Card 14, Port 2 (TX)	7, 32
Card 2, Port 2 (RX)	Card 8, Port 2 (RX)	Card 14, Port 2 (RX)	8, 33
Card 3, Port 1 (TX)	Card 9, Port 1 (TX)	Card 15, Port 1 (TX)	9, 34
Card 3, Port 1 (RX)	Card 9, Port 1 (RX)	Card 15, Port 1 (RX)	10, 35
Card 3, Port 2 (TX)	Card 9, Port 2 (TX)	Card 15, Port 2 (TX)	11, 36
Card 3, Port 2 (RX)	Card 9, Port 2 (RX)	Card 15, Port 2 (RX)	12, 37
Card 4, Port 1 (TX)	Card 10, Port 1 (TX)	Card 16, Port 1 (TX)	13, 38
Card 4, Port 1 (RX)	Card 10, Port 1 (RX)	Card 16, Port 1 (RX)	14, 39
Card 4, Port 2 (TX)	Card 10, Port 2 (TX)	Card 16, Port 2 (TX)	15, 40
Card 4, Port 2 (RX)	Card 10, Port 2 (RX)	Card 16, Port 2 (RX)	16, 41
Card 5, Port 1 (TX)	Card 11, Port 1 (TX)	Card 17, Port 1 (TX)	17, 42
Card 5, Port 1 (RX)	Card 11, Port 1 (RX)	Card 17, Port 1 (RX)	18, 43
Card 5, Port 2 (TX)	Card 11, Port 2 (TX)	Card 17, Port 2 (TX)	19, 44
Card 5, Port 2 (RX)	Card 11, Port 2 (RX)	Card 17, Port 2 (RX)	20, 45
Card 6, Port 1 (TX)	Card 12, Port 1 (TX)	Card 18, Port 1 (TX)	21, 46
Card 6, Port 1 (RX)	Card 12, Port 1 (RX)	Card 18, Port 1 (RX)	22, 47
Card 6, Port 2 (TX)	Card 12, Port 2 (TX)	Card 18, Port 2 (TX)	23, 48
Card 6, Port 2 (RX)	Card 12, Port 2 (RX)	Card 18, Port 2 (RX)	24, 49

Hotwire 8784 Front Panel 50-pin DTE Connector Pinouts

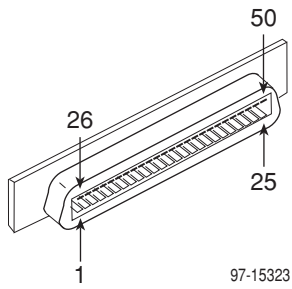

The DTE connectors on the 8784 termination unit provide the 4-wire DSX-1 interface from each DSL port to the DTE. The following table lists the pin assignments for each of these interfaces.

DSX-1 Port	50-Pin Connector Pinout	Function
Port 2	30	Data Out (Ring)
	5	Data Out (Tip)
	29	Data In (Tip)
	4	Data In (Ring)
Port 1	27	Data Out (Ring)
	2	Data Out (Tip)
	26	Data In (Tip)
	1	Data In (Ring)

Technical Specifications

D

Specifications	Criteria*
Size	Length 10 inches (25.4 cm) Height 12.3 inches (31.1 cm) Width 0.8 inch (2.0 cm)
Weight	Approximately 1.3 lbs. (0.6 kg)
Approvals Safety Certifications	Refer to the equipment's label for approvals on product.
Power	The 8784 Termination Unit contains a DC-to-DC converter that requires -48V power input. The -48V power is distributed through the Hotwire DSLAM backplane. Maximum Power Dissipation = 19 watts
Physical Environment Operating temperature Storage temperature Relative humidity Shock and vibration	32° to 122° F (0° to 50° C) -4° F (-20° C) to 158° F (70° C) 5% to 85% (noncondensing) Withstands normal shipping and handling.
* Technical specifications are subject to change without notice.	

Glossary

511	A random bit test 511 bytes in length.
AMI	Alternate Mark Inversion. A line coding technique used to accommodate the ones density requirements of E1 or T1 lines.
ATI	Asynchronous Terminal Interface. A menu-driven, VT100-compatible system for configuring and managing the termination unit.
B8ZS	Bipolar 8 Zero Substitution. Encoding scheme for transmitting clear channel signals over a T1 line.
BPV	Bipolar Violation. In a bipolar signal, a one (mark, pulse) which has the same polarity as its predecessor.
bridged tap	Any part of the local loop that is not in the direct talking path between the CO and the service user.
CD	Carrier Detect. The received line signal detector. V.24 circuit 109.
CO	Central Office/Central Site. The PSTN facility that houses one or more switches serving local telephone subscribers.
COM port	Communications port. A computer's serial communications port used to transmit to and receive data from a modem. The modem connects directly to this port.
CP	Customer Premises.
CPE	Customer Premises Equipment. Terminal equipment on the service user's side of the telecommunications network interface.
CPU	Central Processing Unit. The main or only computing device in a data processing system.
CRC	Cyclic Redundancy Check. A mathematical method of confirming the integrity of received digital data.
CV	Code Violation. Detected when using HDB3 coding format, this is equivalent to a BPV when using AMI coding.
D4	The transmission standard that specifies 12 frames as a superframe that is used for frame synchronization and to locate signaling bits.
DCE	Data Communications Equipment. The equipment that provides the functions required to establish, maintain, and end a connection. It also provides the signal conversion required for communication between the DTE and the network.
DCLB	Data Channel LoopBack. Loops the data received from the network interface, for all DS0 channels allocated to the selected port, back to the network.
DSL	Digital Subscriber Line. The non-loaded, local-loop copper connection between the customer and the first node within the network.
DSLAM	Digital Subscriber Line Access Multiplexer. A platform for DSL modems that provides high-speed data transmission over traditional twisted-pair wiring.
DSR	Data Set Ready. A signal from the modem to the DTE that indicates the modem is turned ON and connected to the DTE.

DSX-1	Digital Signal Cross Connect level 1. An interconnection point for terminals, multiplexers and transmission facilities.
DTE	Data Terminal Equipment. The equipment, such as a computer or terminal, that provides data in the form of digital signals for transmission.
DTLB	Data Terminal LoopBack. Loopback mode that loops the data for a particular synchronous data port back to the port just before it is combined with the rest of the T1 data stream.
E1	A wideband digital interface operating at 2.048 Mbps, defined by ITU recommendations G.703 and G.704. It is used primarily outside North America.
EER	Excessive Error Rate. An error rate that is greater than the threshold that has been configured in the device.
EOC	Embedded Operations Channel. An in-band channel between DSL devices, used for 4 kbps management data.
ES	Errored Seconds. A second with one or more ESF error events (one or more CRC6 error events or OOFs).
ESF	Extended SuperFrame. The T1 transmission standard that specifies 24 frames as an extended superframe to be used for frame synchronization and to locate signaling bits.
Ethernet	A type of network that supports high-speed communication among systems. It is a widely implemented standard for LANs. All hosts are connected to a coaxial cable where they contend for network access using a Carrier Sense, Multiple Access with Collision Detection (CSMA/CD) paradigm.
ETSI	European Telecommunications Standardization Institute. An organization that produces technical standards in the area of telecommunications.
factory defaults	A predetermined set of configuration options containing the optimum settings for operation on asynchronous dial networks.
FAS	Frame Alignment Signal. A loss of signal (LOS) error detection.
FAW	Frame Alignment Word. A loss of synchronization error detection.
FCC	Federal Communications Commission. The Board of Commissioners that regulates all electrical communications that originate in the United States.
FEBE	Far-End Block Error. Block errors reported by remote equipment.
frame relay	A high-speed connection-oriented packet switching WAN protocol using variable-length frames.
FTP	File Transfer Protocol. A TCP/IP standard protocol that allows a user on one host to access and transfer files to and from another host over a network, provided that the client supplies a login identifier and password to the server.
G.703	An ITU recommendation for the physical and logical characteristics of hierarchical digital devices.
G.704	An ITU recommendation for synchronous frame structures.
HDB3	High Density Bipolar Three Zeros Substitution. A line coding technique used to accommodate the ones density requirements of E1 lines.
IP	Internet Protocol. An open networking protocol used for internet packet delivery.
IP address	Internet Protocol address. The address assigned to an internet host.
kbps	Kilobits per second. One kilobit is usually taken to be 1,024 bits.

LAN	Local Area Network. A privately owned and administered data communications network limited to a small geographic area.
LED	Light Emitting Diode. A light or status indicator that glows in response to the presence of a certain condition (e.g., an alarm).
LLB	Line LoopBack. A test in which the received signal on the network interface is looped back to the network without change.
loopback	A diagnostic procedure that sends a test message back to its origination point. Used to test various portions of a data link in order to isolate an equipment or data line problem.
LOS	Loss of Signal. The E1 line condition where there are no pulses.
LTU	Line Termination Unit. The control unit on the network end of a link. (The NTU is on the customer premises end.)
Mbps	Megabits per second. One megabit is 1,048,576 (1024 ²) bits.
MCC	Management Communications Controller. The DSLAM circuit card used to configure and monitor the DSLAM.
MIB	Management Information Base. A database of managed objects used by SNMP to provide network management information and device control.
MIB II	MIB Release 2. The current Internet-standard MIB, defined by RFC 1213.
M/SDSL	Multirate SDSL.
MTSO	Mobile Telephone Switching Office. A generic name for the main cellular switching center which supports multiple base stations.
NMS	Network Management System. A computer system used for monitoring and controlling network devices.
NTU	Network Termination Unit. The unit on the customer premises end of a link. (The LTU is on the network end.)
OOF	Out Of Frame. An error condition in which frame synchronization bits are in error.
reset	An initialization of the device that occurs at power-up or in response to a reset command.
RLB	Repeater LoopBack. Loops the signal being sent to the network back to the DTE Drop/Insert and data ports after it has passed through the framing circuitry of the device.
router	A device that connects LANs by dynamically routing data according to destination and available routes.
SDSL	Symmetrical Digital Subscriber Line. A technique for the use of an existing twisted-pair line that permits high bandwidth, bidirectional transmission.
SES	Severely Errored Seconds. Usually defined as a second during which a specific number of CRC errors was exceeded, or an OOF or other critical error occurred.
SNMP	Simple Network Management Protocol. Protocol for open networking management.
T1	A term for a digital carrier facility used to transmit a DS1 formatted digital signal at 1.544 Mbps. It is used primarily in North America.
TCP/IP	Transmission Control Protocol/Internet Protocol. The dominant protocol suite in the worldwide Internet, TCP allows a process on one machine to send data to a process on another machine using the IP. TCP can be used as a full-duplex or one-way simplex connection.

Telnet	Virtual terminal protocol in the Internet suite of protocols. Allows the user of one host computer to log into a remote host computer and interact as a normal terminal user of the remote host.
TFTP	Trivial File Transfer Protocol. A standard TCP/IP protocol that allows simple file transfer to and from a remote system without directory or file listing. TFTP is used where FTP is not available.
TXD	Transmit Data. Pin 2 of the EIA-232 interface that is used by the DTE to transmit data to the modem. Conversely, the modem uses Pin 2 to receive data from the DTE.
UNIX	An operating system developed at AT&T Bell Laboratories and since used as the basis of similar operating systems.
WAN	Wide Area Network. A network that spans a large geographic area.

Index

A

Abort All Tests, 5-1
access
 SNMP, 1-4, 7-4
 to async terminal interface, 2-5
access level
 effective, 7-1
 functions available for, 7-1
administer login, 7-2
AIS, A-5
AIS (Alarm Indication Signal), status message, 4-3
Alarm, LED, 4-13
ASCII, printable characters, 3-2
ATI (Asynchronous Terminal Interface)
 access, 2-1
 defined, 1-1
 exiting, 2-11
 initiating session, 2-4
 virtual function keys, 2-9
authenticationFailure, B-1

C

cables, rear panel, C-1
Card Failed
 self-test result, 4-5
 status message, 4-4
Card Selection screen, 2-3
Circuit Identifier, A-3
Clock Failed, status message, 4-4
Community Name , A-14, A-15
Community Name 1, A-14
Community Name 2, A-15
community names, for SNMP, 7-4
configuration
 Copy Port Options, A-6
 DSX-1 Interface Options , A-4
 example, 1-3
 General SNMP Management Options, A-14
 Network Interface Options, A-2
 option tables, A-1
 SNMP Management, A-14
 SNMP NMS Security Options, A-14, A-16

 SNMP Trap Options, A-11
 System Options, A-7
 Telnet Session Options, A-9
configuration changes, saving, 3-8
Configuration Edit/Display, 3-5
Configuration Loader, 3-6
Configuration menu, 3-4
configuration options
 Copy Ports, A-6
 DSX-1 Interface, A-4
Copy Ports Options, A-6
CPU Fail, self-test result, 4-5
create login ID, 7-2
customer configuration areas, 3-3

D

default configuration area, 3-3
delete, Login ID, 7-4
device
 messages, 6-3– 6-4
 name, 3-2
dimensions, D-1
Disconnect Time, for Telnet session, A-10
documents, related, vi
DOS, TFTP server on, 3-6
download code, 3-9
Download Failed, status message, 4-4
DSL Port, LEDs, 4-13
DSLAM
 card selection, 2-3
 defined, 1-2
 exiting from session, 2-11
 login, 2-2
DSX-1 Interface Option settings, A-4
DSX-1 Interface Options, A-4
DSX-1 port, LEDs, 4-13
DTE loopback , 5-5

E

- EER (Excessive Error Rate) , status message, 4-3
- effective access level, 7-1
- ending an ATI session, 2-11
- enterprise, SNMP traps, B-3
- Enterprise Specific Traps, A-12
- environment requirements, D-1
- error messages, line 24, 6-3
- error statistics, 4-7
- Excessive Error Rate (EER) Threshold, A-2

F

- factory defaults, 3-3
- Failure, self-test result, 4-5
- features, 1-1
- firmware, download from server, 3-9

G

- G.703 Interface Options, A-4
- General SNMP Options, A-14
- General SNMP Traps Options, A-14
- General Traps, A-12

H

- health and status messages, 4-3

I

- identity, 3-2
- inactivity timeout, for Telnet session, A-10
- intended audience, v
- IP address
 - DSL peer, A-3
 - SNMP manager, 7-5
- IP addresses, 8-1
- IP addressing, example, 8-2

K

- keyboard functions, 2-8

L

- lamp test, 5-8
- LEDs, 4-12, 4-13
- Line Coding Format, A-5
- Line Equalization, A-5
- Line Framing , A-4
- Link Up, LEDs, 4-13
- link-layer protocols, 8-1
- linkUp and linkDown traps, B-2
- local line loopback (LLB), 5-3
- LOF (Loss Of Frame), status message, 4-3
- login, DSLAM, 2-2
- Login ID
 - access levels, 7-1
 - adding, 7-2
 - deleting, 7-4
- login ID, 7-1
- loopback, effect on LEDs, 4-13
- LOS (Loss Of Signal), status message, 4-3

M

- main menu, 2-4
- Management and Communication Options, A-9
- management port
 - access, 7-1
 - settings, 2-1
- Margin Threshold, A-2
- MCC, defined, 1-2
- Memory Fail, status, 4-5
- messages
 - alarm and device, 6-1
 - health and status, 4-3
 - line 24, 6-3
 - self-test results, 4-5
 - test status, 4-6
- MIB
 - general support, 1-4
 - support, 1-5
- MIB definitions, 1-4
- monitoring, 4-1

N

- navigating the screens, 2-8
- Net Margin Threshold, status message, 4-4
- network, tests, 5-2
- Network DSL Failed, self-test result, 4-5
- Network Interface Options, A-2
 - Circuit Identifier, A-3
 - Excessive Error Rate Threshold, A-2
 - Margin Threshold, A-2
 - Peer IP Address, A-3
- NMS
 - SNMP access, 7-5
 - SNMP connectivity, 8-1
- no test active status message, 4-6

O

- OK, LED, 4-13
- OOE (Out Of Frame), status message, 4-3
- options, configuration tables, A-1
- overview
 - 8775 Termination Unit, 1-1
 - user's guide, v

P

- Passed, self-test result, 4-5
- Peer IP Address, A-3
- performance statistics, 4-8
 - DSX-1, 4-10
- physical environment requirements, D-1
- pin assignments, C-1
- Port Status, A-4
- power requirements, D-1
- Primary Clock Source, A-5

R

- related documents, vi
- remote send line loopback, 5-6
- repeater loopback (RLB), 5-4
- reset, ATI, 3-9
- restore access to ATI, 3-9

S

- Save Configuration screen, 3-8
- saving option changes, 3-8
- screen, function keys, 2-9
- screens, for user interface, 2-1– 2-6
- SDSL Mode, A-7
- security, 7-1
- self-test results, 4-5
- Send and Monitor 511, 5-7
- Send Remote Line Loopback, 5-6
- size of card, D-1
- SNMP
 - system entries, 3-2
 - trap options, 6-2
 - traps, B-1
- SNMP Management Configuration, A-14
- SNMP management
 - general, 1-4
 - limiting access, 7-4
- SNMP NMS Security Options, A-16
- SNMP Trap Options, A-11
 - Enterprise Specific Traps, A-12
 - Link Trap Interfaces, A-13
 - Link Traps, A-13
 - NMS n Destination, A-12
 - NMS n IP Address, A-12, A-17
 - Number of Trap Managers, A-11
 - SNMP Traps, A-11
- SNMP Traps, enable/disable, A-11
- start-up, ATI, 2-1
- status, test messages, 4-6
- subnet, IP addresses, 8-1
- system
 - device name fields, 3-2
 - LEDs, 4-13
- System Options
 - DSL Mode, A-7
 - Test Duration, A-7
 - Test Timeout, A-7

T

- Telco Initiated Loopback, A-8
- Telnet session
 - access level, A-10
 - enable/disable, A-9
 - login required, A-10
- telnet session access, 7-1
- Telnet Session Options
 - Disconnect Time (Minutes), A-10
 - inactivity timeout, A-10
 - Session Access Level, A-10
 - Telnet Login Required, A-10
 - Telnet Session, A-9
- telnet session options, A-9
- terminal port, direct connection, 2-1
- test
 - aborting, 5-9
 - DTE Loopback, 5-5
 - LED, 4-13
 - Line Loopback, 5-3
 - Remote Send Line Loopback, 5-6
 - Repeater Loopback, 5-4
 - Send and Monitor 511, 5-7
 - status messages, 4-6
 - terminating, 5-9
 - Test Duration, A-7
 - Test Timeout, A-7
- Test menu, 5-2
- testing, 5-1
- timeout
 - Telnet session inactivity, A-10
 - Test, A-7
- traps, SNMP, 6-2, B-1
- troubleshooting, 6-5
 - DSX-1 performance statistics, 4-10
 - error statistics, 4-7
 - performance statistics, 4-8

U

- UNIX, TFTP server on, 3-6
- user interface, 1-4
 - access, 3-9
 - async terminal, 2-1
 - how to access, 2-1

V

- virtual function keys, 2-9

W

- warmStart, B-1
- weight of card, D-1